



Low-Cost Solar Water Heating Research and Development Roadmap

K. Hudon, T. Merrigan, J. Burch and J. Maguire
National Renewable Energy Laboratory

NREL is a national laboratory of the U.S. Department of Energy, Office of Energy Efficiency & Renewable Energy, operated by the Alliance for Sustainable Energy, LLC.

Technical Report
NREL/TP-5500-54793
August 2012

Contract No. DE-AC36-08GO28308

Low-Cost Solar Water Heating Research and Development Roadmap

K. Hudon, T. Merrigan, J. Burch and J. Maguire
National Renewable Energy Laboratory

Prepared under Task No. SHX1.1001

NREL is a national laboratory of the U.S. Department of Energy, Office of Energy Efficiency & Renewable Energy, operated by the Alliance for Sustainable Energy, LLC.

NOTICE

This report was prepared as an account of work sponsored by an agency of the United States government. Neither the United States government nor any agency thereof, nor any of their employees, makes any warranty, express or implied, or assumes any legal liability or responsibility for the accuracy, completeness, or usefulness of any information, apparatus, product, or process disclosed, or represents that its use would not infringe privately owned rights. Reference herein to any specific commercial product, process, or service by trade name, trademark, manufacturer, or otherwise does not necessarily constitute or imply its endorsement, recommendation, or favoring by the United States government or any agency thereof. The views and opinions of authors expressed herein do not necessarily state or reflect those of the United States government or any agency thereof.

Available electronically at <http://www.osti.gov/bridge>

Available for a processing fee to U.S. Department of Energy and its contractors, in paper, from:

U.S. Department of Energy
Office of Scientific and Technical Information
P.O. Box 62
Oak Ridge, TN 37831-0062
phone: 865.576.8401
fax: 865.576.5728
email: <mailto:reports@adonis.osti.gov>

Available for sale to the public, in paper, from:

U.S. Department of Commerce
National Technical Information Service
5285 Port Royal Road
Springfield, VA 22161
phone: 800.553.6847
fax: 703.605.6900
email: orders@ntis.fedworld.gov
online ordering: <http://www.ntis.gov/help/ordermethods.aspx>

Cover Photos: (left to right) PIX 16416, PIX 17423, PIX 16560, PIX 17613, PIX 17436, PIX 17721



Printed on paper containing at least 50% wastepaper, including 10% post consumer waste.

Table of Contents

List of Figures	v
List of Tables.....	viii
Executive Summary	ix
Nomenclature.....	xviii
1 Introduction	1
1.1 U.S. Department of Energy Goals	2
1.1.1 Office of Energy Efficiency and Renewable Energy.....	2
1.1.2 Building Technologies Program	3
1.1.3 Low-Cost Solar Water Heating R&D Goals.....	3
1.2 Roadmap Objective.....	4
1.3 Roadmap Development Process	4
2 Technology and Market Status	5
2.1 Solar Water Heating Technology.....	5
2.2 Performance and Economics.....	7
2.2.1 Performance Comparisons	7
2.2.2 Solar Water Heater Economics.....	13
2.3 Domestic Solar Thermal Market.....	15
2.3.1 Solar Water Heating Accomplishments.....	19
2.3.2 Competing Technologies	20
2.3.3 Global Solar Thermal Market.....	21
2.3.4 Opportunities and Market Growth Potential for Low-Cost Systems.....	24
2.4 Low-Cost Solar Systems.....	26
3 Materials, Manufacturing, and Labor Resource Status.....	30
3.1 Material Requirements.....	30
3.1.1 Collectors	30
3.1.2 Storage	31
3.1.3 Balance of Systems.....	31
3.2 Manufacturing Capabilities.....	31
3.3 Labor Resources.....	35
3.3.1 Manufacturing.....	36
3.3.2 Design and Installation	36
3.3.3 Operations and Maintenance.....	36
4 Technology Improvements and Research Needs.....	37
4.1 Pathway Option 1—Polymers.....	39
4.1.1 Solar Collectors.....	45
4.1.1.1 Absorbers	46
4.1.1.2 Glazings	47
4.1.2 Thermal Storage.....	49
4.1.2.1 Membrane Tanks	50
4.1.2.2 Rotomolded Rigid Tanks	50
4.1.3 Balance of System and Controls.....	51
4.1.3.1 Low-Cost Heat Exchangers	51
4.1.3.2 Piping.....	51
4.1.4 System Engineering and Integration.....	52
4.2 Pathway Option 2—Cold Climate Thermosiphon.....	53
4.2.1 Polymer Film Thermosiphon	55

4.2.2	Evacuated Tube Thermosiphon	55
4.2.3	Freeze Concern for Cold Climate Thermosiphons	56
4.3	Research and Development Priorities	57
4.3.1	Materials Testing: Priority 1	58
4.3.2	Polymer Components: Priorities 1 and 2	58
4.3.2.1	Polymer Heat Exchangers: Priority 1	58
4.3.2.2	Polymer Tank: Priority 1	58
4.3.2.3	Polymer Piping: Priority 2	58
4.3.3	Other Component Research: Priorities 2 and 3	59
4.3.3.1	Integrated Valving Package: Priority 2	59
4.3.3.2	Mounting Methods: Priority 3	59
4.3.3.3	Installation Costs: Priority 3	59
4.3.4	Soft Costs Research: Priority 3	59
5	Low-Cost Solar Water Heating Challenges and Barriers.....	60
5.1	Market Challenges and Barriers.....	60
5.2	Technical (Nonmarket) Challenges and Barriers.....	61
5.3	Strategies/Pathways to Overcoming Challenges/Barriers	62
5.4	Industry Feedback.....	63
5.5	Low-Cost Solar Water Heating R&D Plan.....	65
6	Summary and Conclusions.....	70
7	References.....	72
Appendix A. Solar Collector Technology.....		78
Appendix B. Calculating Source Energy Savings.....		80
Appendix C. Solar Pool Heating Technology and Market Status		97
Appendix D. Material Specifications for a Polymer Solar Water Heating System		100
Appendix E. Price Fluctuations for Commodities.....		101

List of Figures

Figure ES-1. Annual source energy savings for HPWH and SWH technologies versus conventional electric resistance water heating	ix
Figure ES-2. Annual source energy savings for HPWH and SWH technologies versus conventional natural gas WHs.....	x
Figure ES-3. “Go/no go” annual source energy savings for a HPWH versus gas WH in conditioned space, furnace/AC case.....	xi
Figure ES-4. Incident probability of an insulated copper pipe over a 20-year system lifetime	xi
Figure ES-5. Residential SWH break-even cost (\$/system) for the top 1,000 natural gas utilities (as of 2008) for a SWH with a natural gas auxiliary WH	xii
Figure ES-6. Potential SWH cost reduction R&D pathway.....	xv
Figure ES-7. Residential low-cost SWH research activity—project and R&D timelines	xvii
Figure 1. 2008 building energy end-use splits for residential (left) and commercial (right) buildings	1
Figure 2. Flat-plate collector.....	5
Figure 3. Evacuated tube collector	5
Figure 4. Diagram of an indirect forced circulation SWH system	6
Figure 5. Commercial SWH system – IKEA Orlando.....	6
Figure 6. Schematic of HPWH technology	8
Figure 7. Annual source energy savings for HPWH and SWH technologies versus conventional electric resistance WHs.....	8
Figure 8. Annual source energy savings for HPWH and SWH technologies versus conventional natural gas WHs	9
Figure 9. “Go/no go” annual source energy savings for an HPWH versus gas WH in conditioned space, furnace/AC case.....	10
Figure 10. Freeze incident probability of an insulated copper pipe over a 20-year system lifetime	11
Figure 11. Residential and commercial WHs, % of units by energy source	12
Figure 12. Regional distribution (by U.S. census region) of the number of houses using a particular water heating fuel type.....	13
Figure 13. Residential SWH break-even cost (\$/system) for the top 1,000 natural gas utilities (as of 2008) for an SWH with a natural gas auxiliary WH and using all incentives	14
Figure 14. U.S. residential WH shipments, 1990–2009	15
Figure 15. U.S. SWH system installations, 1974 to first half 2010	16
Figure 16. U.S. solar thermal collector shipments, 1974–2008.....	16
Figure 17. U.S. solar thermal collector shipments (including imports/exports).....	17
Figure 18. SWH collector area shipments between 2007 and 2010 (1,000 ft ²)	17
Figure 19. First half 2010 SWH collector area shipped for the top 20 states	18
Figure 20. Monthly average price of natural gas delivered to U.S. residential, commercial, and industrial consumers, 1981–2011.....	18
Figure 21. U.S. SWH system installations, 2005–2010.....	19
Figure 22. FAFCO polymer SWH collectors.....	20
Figure 23. FAFCO SWH system	20
Figure 24. First cost of SWH systems compared to other water heating methods.....	21
Figure 25. World renewable energy capacity and energy production, 2011	21
Figure 26. Glazed and evacuated tube collector capacity per 1,000 inhabitants, 2011	22
Figure 27. World market for solar thermal collector installations	22
Figure 28. Glazed and evacuated tube collector capacity (kW _{th} /1000), 2000–2008	23
Figure 29. 2008 market shares for residential WHs	24
Figure 30. WH portfolios for Rheem	24
Figure 31. Average residential natural gas prices for AEO and high price cases	25
Figure 32. Residential SWH system installations for four market penetration scenarios	26
Figure 33. Installed SWH system costs.....	27
Figure 34. U.S. SWH component market values.....	30
Figure 35. 2010 North American map of flat-plate collector manufacturers	32

Figure 36. Average warranty period of flat-plate and evacuated tube collectors	33
Figure 37. 2011 world map of flat-plate collector manufacturers	34
Figure 38. 2011 world map of evacuated tube collector manufacturers.....	35
Figure 39. SWH TIOs. Shading indicates degree of impact each TIO has on each metric: red (dark) is high; yellow (light) is medium; no shading is low.....	38
Figure 40. San Diego 2007–2010 single family SWH cost breakdown (\$/ft ²).....	39
Figure 41. First cost and levelized cost of saved energy for a series of BOS and collector changes. Marketing cost is set at 20% of the system cost, resulting in an overall cost reduction once the BOS and collector changes are applied.	40
Figure 42. Schematic for SRCC TRNSYS model of a “typical” SWH system with a gas auxiliary WH (OG-300 System Reference: 2010016B).....	41
Figure 43. Schematic of low-cost polymer film membrane tank with immersed load-side HX and solar-loop pump	43
Figure 44. Prototype low-cost polymer HX. Tubes are 1/8 in. (3 mm) diameter. Tube production, tube weaving, and tube-to-header welding are automated processes, contributing to a low-cost projection.....	44
Figure 45. Prototype polymer collector, made primarily with fluorocarbon films seam-welded to form the absorber, a stretched film glazing, and an aluminum frame	44
Figure 46. Thermotropic polyamide in clear and scattering states.....	47
Figure 47. Test results on 3 brands of clear PC with a UV-absorber top coating, at temperatures of 20°C (open symbols) and 60°C (solid symbols)	48
Figure 48. Large format collectors for Dallas Convention Center.....	49
Figure 49. Flat-plate collector cost per area	49
Figure 50. Rectangular membrane storage tank	50
Figure 51. Unpressurized rotomolded tanks with immersed stainless steel HXs	51
Figure 52. Probability of a pipe freeze over a 20-year system lifetime (left); water wasted by a freeze protection valve in a direct system (right)	52
Figure 53. SWH schematics: (a): 1-tank glycol system, with solar tank having immersed HX; (b) non-separable thermosiphon; and (c) natural convection loop schematic	53
Figure 54. Component substitution path for a thermosiphon system in a new construction scenario. BOS measures are followed by collector substitution and market cost reduction, indicating about \$1,000 cost. The last point on the right is for the polymer film thermosiphon described below.	54
Figure 55. Polymer film thermosiphon collector/storage concept (left) and first 24 ft ² unglazed prototype to test (right)	55
Figure 56. Evacuated tube collectors: double wall with heat pipe.....	56
Figure 57. Low-cost thermosiphon configuration, with a direct collector loop, membrane storage in the attic, load-side HX, and PEX supply/return piping with a FPV as primary freeze protection.....	57
Figure 58. U.S. water heating available market versus SWH system cost.....	61
Figure 59. Polling results from Low-Cost Solar Water Heating webinar	64
Figure 60. Residential low-cost SWH research activity—project and R&D timelines	67
Figure 61. WBS for low-cost SWHs	68
Figure 62. WBS for solar-assisted HPWHs	69
Figure A–1. Glazed flat-plate collector. <i>Photo by Christopher Drake, NREL/PIX 09188</i>	78
Figure A–2. Evacuated tube collector. <i>Photo by Alan Ford, NREL/PIX 09501</i>	79
Figure B–1. Efficiency zones—Rheem hybrid electric HPWH technology (Rheem, used by Permission) www.rheem.com/Products/tank_water_heaters/Hybrid_electric/efficiency	80
Figure B–2. Annual Energy Savings: HPWH versus electric resistance WH	82
Figure B–3. Annual Energy Savings: HPWH versus natural gas WH	83
Figure B–4. “Go/no go” annual source energy savings for an HPWH versus gas WH in conditioned space, furnace/air-conditioning case.....	85
Figure B–5. Schematic for SRCC TRNSYS model of a “typical” SWH system with a gas auxiliary WH (OG-300 System Reference: 2010016B) (SRCC, used by permission).....	86
Figure B–6. Curve of energy saved versus collector area for four discrete system sizes and select states.....	86

Figure B–7. Annual source energy savings for HPWH and SWH technologies versus electric resistance WH	89
Figure B–8. Annual source energy savings for HPWH and SWH technologies versus natural gas WH	89
Figure B–9. Annual source energy savings for HPWH and SWH technologies versus electric resistance water heating for set point temperatures of 120°F and 130°F	91
Figure B–10. Source energy savings for solar versus natural gas WH for a set point temperature of 130°F.....	92
Figure B–11. Annual source energy savings for HPWH and SWH technologies versus electric resistance WH for low and high hot water use	94
Figure B–12. Annual source energy savings for HPWH and SWH technologies versus natural gas WH for low and high hot water use	96
Figure C–1. Photo of polymer solar pool collectors. <i>Photo from Aquatherm Industries, NREL/PIX 07175</i>	97
Figure C–2. U.S. solar thermal collector shipments by end use, 2008	98
Figure C–3. U.S. solar pool heating system installations, 1974—first half 2010. (SEIA, used by permission).....	98
Figure C–4. Annual installed capacity by market segment, 2000–2010. (SEIA, used by permission)	99
Figure E–1. Copper ores producer price index—commodities, 1994–2011	101
Figure E–2. Aluminum mill shapes producer price index—commodities, 1994–2011	101
Figure E–3. Iron and steel producer price index—commodities, 1994–2011	101
Figure E–4. Copper and copper-based alloy pipe and tube producer price index—commodities, 2005–2011	102
Figure E–5. Plastic pipe producer price index—commodities, 2005–2011	102

Unless otherwise indicated, all figures were created by NREL

List of Tables

Table ES–1. Low-Cost SWH Targets and R&D Strategies To Achieve Program Targets	xiv
Table 1. Annual Source Energy Savings for HPWH and SWH Technologies Versus Conventional Natural Gas and Electric Resistance Water Heating	10
Table 2. Annual Source Energy Savings for Gas Tankless and SWH Technologies Versus Conventional Natural Gas Water Heating.....	11
Table 3. SolarDS-WH SWH Market Penetration Scenarios.....	26
Table 4. Summary of SWH Systems in the United States, Israel, and China	28
Table 5. Impact of Reducing Cost Factors for U.S. SWH Systems	29
Table 6. Base Case System Parameters	41
Table 7. Cost Reduction Measures and Associated Savings	43
Table 8: Advantages and Disadvantages of Thermosiphon Versus Active Systems	54
Table 9. R&D Priorities for Low-Cost SWHs	58
Table 10. Low-Cost SWH Market Challenges and Barriers	60
Table 11: Percentage of U.S. Market at Break-Even Cost Versus Natural Gas	60
Table 12. Low-Cost SWH Technical Challenges and Barriers	62
Table 13. Low-Cost SWH Targets and R&D Strategies To Achieve Program Targets	63
Table B–1. Site Energy Savings for HPWH (in Conditioned Space) versus Electric Resistance WH	82
Table B–2. Source Energy Savings for HPWH (in Conditioned Space) versus Electric Resistance WH	83
Table B–3. Site Energy Savings for HPWH (in Conditioned Space) versus Natural Gas WH.....	84
Table B–4. Source Energy Savings for HPWH (in Conditioned Space) versus Natural Gas WH	84
Table B–5. Site Energy Savings for Solar versus Electric Resistance WH	87
Table B–6. Source Energy Savings for Solar versus Electric Resistance WH	87
Table B–7. Site Energy Savings for Solar versus Natural Gas Water Heating.....	87
Table B–8. Source Energy Savings for Solar versus Natural Gas Water Heating	88
Table B–9. TRNSYS Parameters Held Constant for HWPB and SWH Simulations	88
Table B–10. Source Energy Savings for HPWH versus Electric Resistance WH for a Set Point Temperature of 130°F	90
Table B–11. Source Energy Savings for Solar versus Electric Resistance WH for a Set Point Temperature of 130°F	90
Table B–12. Source Energy Savings for HPWH versus Natural Gas WH for a Set Point Temperature of 130°F	91
Table B–13. Source Energy Savings for Solar versus Natural Gas WH for a Set Point Temperature of 130°F	92
Table B–14. Source Energy Savings for HPWH versus Electric Resistance WH for Low-Use Home	93
Table B–15. Source Energy Savings for Solar versus Electric Resistance WH for Low-Use Home	93
Table B–16. Source Energy Savings for HPWH versus Electric Resistance WH for High-Use Home	93
Table B–17. Source Energy Savings for Solar versus Electric Resistance WH for High-Use Home	94
Table B–18. Source Energy Savings for HPWH versus Natural Gas WH for Low-Use Home	95
Table B–19. Source Energy Savings for Solar versus Natural Gas WH for Low-Use Home	95
Table B–20. Source Energy Savings for HPWH versus Natural Gas WH for High-Use Home	95
Table B–21 Source Energy Savings for Solar Versus Natural Gas WH for High-Use Home	95

Unless otherwise indicated, all tables were created by NREL

Executive Summary

The objectives of this report are to:

- Identify the target market for solar water heaters (SWHs) that will provide the largest U.S. energy savings potential relative to other advanced water heating technologies.
- Identify potential technology pathways and cost/performance targets that must be met to enable SWH systems to achieve large energy savings.

The market environment for SWH technology has changed substantially with the successful introduction of heat pump water heaters (HPWHs). This energy-efficient technology increases direct competition with SWHs for available energy savings. It is therefore essential to understand which segment of the market is best suited for HPWHs and focus the development of innovative, low-cost SWHs in the market segment with the largest opportunities.

To evaluate cost and performance tradeoffs between high performance water heating systems, annual energy simulations were run using TRNSYS, and analysis was performed to compare the energy savings associated with HPWH and SWH technologies to conventional methods of water heating. Figure ES–1 shows the annual source energy savings for HPWH and SWH technologies compared to a conventional electric resistance water heater (WH).

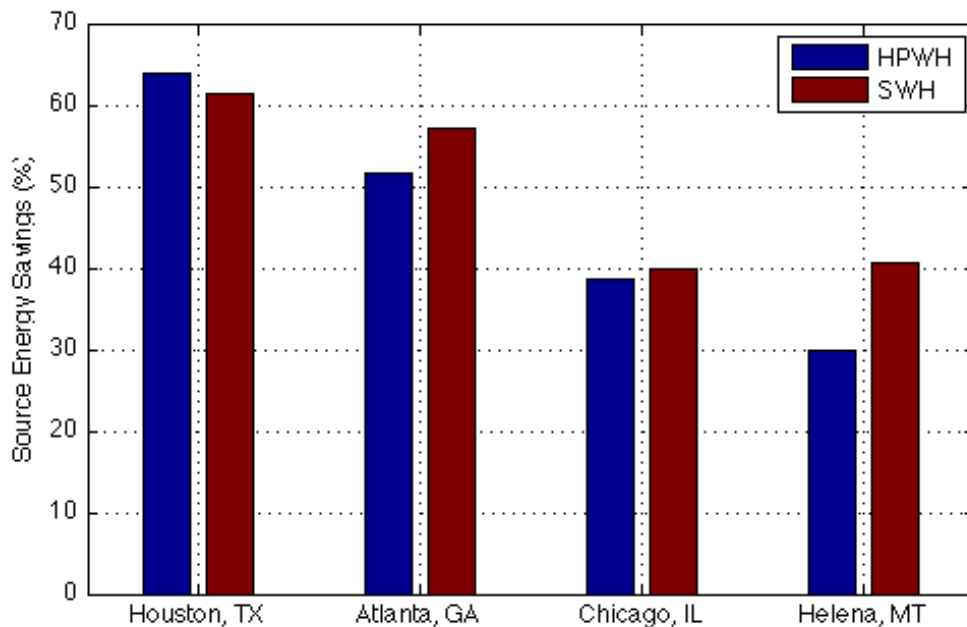

Figure ES–1. Annual source energy savings for HPWH and SWH technologies versus conventional electric resistance water heating

This analysis shows that HPWHs and SWHs will save significant annual source energy over electric resistance WHs, regardless of location. The energy savings between the technologies are similar, so a homeowner could choose either. This will limit the market for SWH systems for regions where electricity is the predominant water heating fuel type.

The comparison with natural gas WHs tells a different story. Figure ES–2 shows the annual source energy savings for HPWH and SWH technologies compared to a conventional natural gas WH. Because the site-to-source ratio for electricity is significantly greater than that of natural gas, replacing a conventional natural gas WH with an HPWH results in negative annual source energy savings in all locations shown except Houston, Texas. In contrast, SWHs save significant source energy relative to a conventional natural gas WH regardless of location.

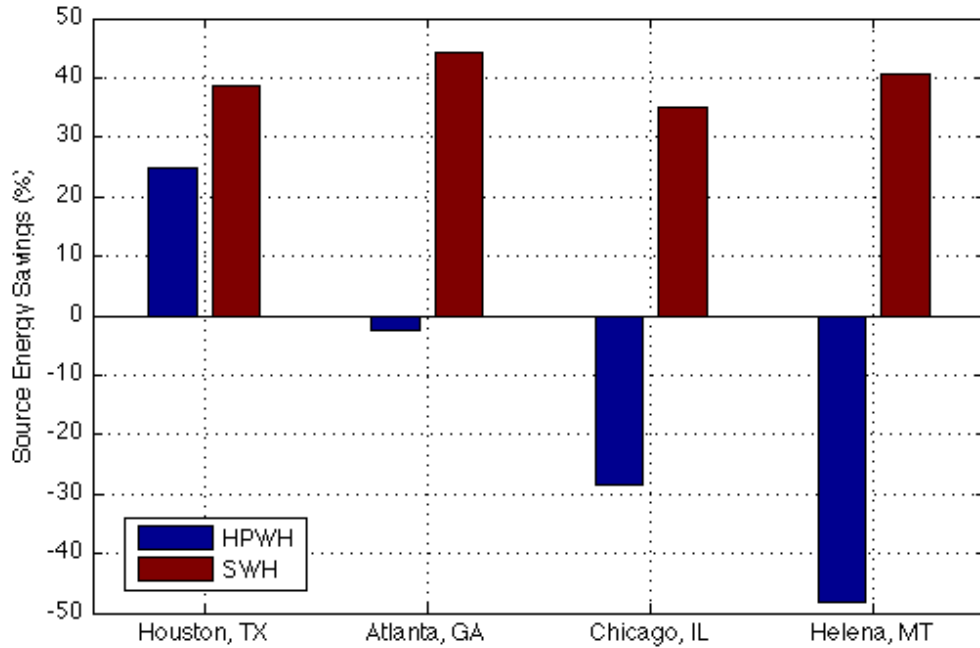

Figure ES–2. Annual source energy savings for HPWH and SWH technologies versus conventional natural gas WHs¹

This result is emphasized in Figure ES–3, which shows the locations where replacing a conventional natural gas WH with an HPWH would result in positive source energy savings. As shown in red, the region of the country with positive energy savings is confined to a narrow market in the hot climates of the southern United States.

¹ SWH source energy savings are displayed in kWh for easy comparison to HPWH technology. This “equivalent kWh” was calculated using the following conversion: 1 therm = 29.3 kWh.

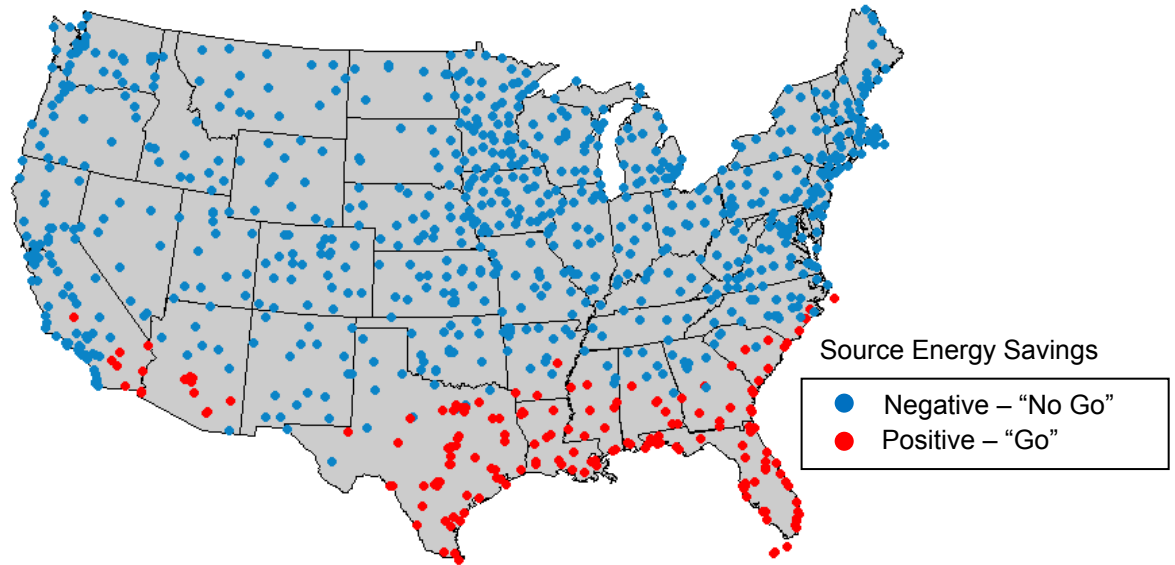

Figure ES-3. "Go/no go" annual source energy savings for a HPWH versus gas WH in conditioned space, furnace/AC case

The results demonstrate that SWH technology must be competitive with conventional natural gas WHs to have broad market impacts. In Figure ES-3, the locations in blue represent the greatest market opportunity for SWHs. This closely corresponds to locations that have a high likelihood of experiencing freeze conditions at some point during the year, as shown in Figure ES-4.

Probability of at Least One Pipe Freeze in 20 Years

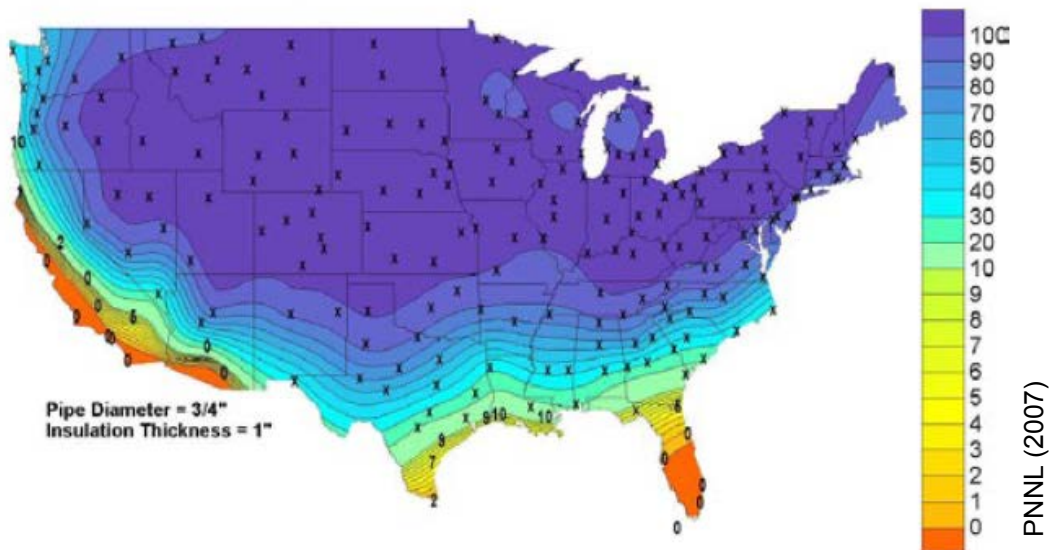

Figure ES-4. Incident probability of an insulated copper pipe over a 20-year system lifetime

Therefore, the focus of the SWH activity should be on innovative low-cost solutions with adequate freeze protection and applicability to cold climates. Such systems could be used in all U.S. locations; however, they need to be optimized for cold climates such that they yield sufficient savings to be worthwhile, and such that freezing conditions are not a concern for long-term durability in the target market. The other reason to focus on cold climates is because the U.S. Department of Energy (DOE) and the National Renewable Energy Laboratory (NREL) have already developed, in collaboration with industry, simple and effective SWHs for regions that do not experience freeze conditions (Burch et al. 2005).

SWHs can save significant source energy in the defined market segment. Some of the current SWH designs can be used in cold climates, but the solar market makes up less than 1% of the U.S. water heating market (EIA 2009). A major barrier to achieving market penetration is the cost of an installed SWH system. Current installed costs are \$6,000–\$10,000, and as shown in Figure ES–5, SWH systems need to drop to \$1,000–\$3,000 for a significant number of U.S. SWHs to be at break-even cost with natural gas. Break-even conditions are defined as the point where the cost of SWH-generated energy equals the cost of a conventional heating fuel purchased from the grid (in this case, natural gas) (Cassard et al. 2011a). This is essentially the point at which the net present cost of the system (installation plus maintenance) is equal to its net present benefits (the value of reduced fuel expenditures plus any incentives).

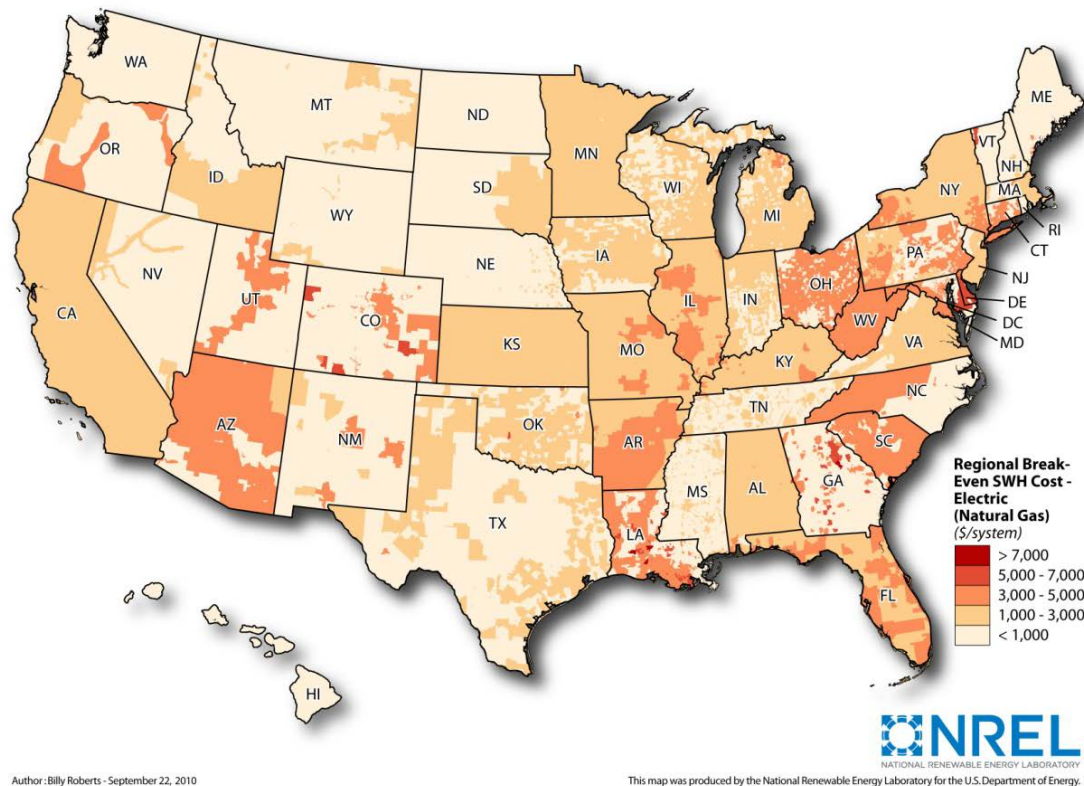

Figure ES–5. Residential SWH break-even cost (\$/system) for the top 1,000 natural gas utilities (as of 2008) for a SWH with a natural gas auxiliary WH

This report focuses on the natural gas market segment in cold climates and outlines a near-term strategy to reduce the installed system costs and maintain the overall energy savings associated with SWH technology. This roadmap provides a guide for the DOE Building Technologies Program as it refocuses its SWH research and development (R&D) efforts. The activities outlined will complement other water heating technologies, such as HPWHs, and can have accelerated broad impacts in the primary market that is expected to offer the largest opportunity: water heating in cold climates where natural gas is the primary water heating fuel type.

Based on our analysis, a factor of three to five reduction in current SWH cost, without compromising durability or performance, is needed to transform this market. The low-cost SWH R&D activity has set the following cost, performance, and reliability targets:

- \$1,000–\$3,000 total installed SWH system cost in existing homes at large market scale
- Maintain conventional SWH systems' 35%–40% source energy savings over conventional natural gas WHs in cold climates
- 15–25 year product lifetime with high system and component reliability and performance.

If these cost, performance, and reliability targets for SWHs can be met in cold climates where natural gas is the predominant water heating fuel, significant savings in energy use, utility bills, and carbon can be achieved relative to those provided by other water heating technologies.

The R&D strategies to achieve the targets of this activity are shown in Table ES–1. Achieving these targets will require innovative alternatives to a mature technology. SWH systems need to be simplified to reduce the number of components, and in turn, the installation and maintenance costs. New materials need to be researched and analyzed. Polymer materials are extremely promising. They will significantly reduce the cost of a collector and its weight, which will simplify installation and reduce installation costs. Evacuated tube solar collectors are also a promising technology that could incorporate a passive system design. It is believed that industry partnerships will enable the success of such innovative systems.

Table ES–1. Low-Cost SWH Targets and R&D Strategies To Achieve Program Targets

Cost	<ul style="list-style-type: none"> • Industry partnerships to develop innovative low-cost SWH systems that can have broad market impacts • Polymer heat exchangers and integrated polymer piping for lower cost balance of systems • Passive SWH systems to eliminate the cost of pumps and controls • Polymer or membrane tanks for lower cost thermal storage • Polymer absorbers and polymer glazings for lower cost SWH collectors • Evacuated glass solar tubes for lower cost SWH collectors • Lightweight SWH collectors and systems for lower cost installation • Fewer components to minimize onsite assembly for lower cost installation, including integrating valving packages
Performance	<ul style="list-style-type: none"> • Innovative SWH system concepts to maintain system performance (35%–40% source energy savings) over conventional natural gas WHs in cold climates • Larger format collectors for greater performance and economies of scale in commercial/industrial application • Selective surface polymer absorbers for greater collection efficiency • Integration with HPWHs for higher performance
Reliability	<ul style="list-style-type: none"> • Accelerated solar radiation exposure and high-temperature testing for more reliable, longer lasting SWH absorbers and glazings • Simple and reliable overheat protection and freeze protection • Innovative antifreeze fluids to meet freeze and cost requirements • Passive SWH systems to eliminate maintenance of pumps and controls • High-temperature and pressure testing for polymer heat exchangers and piping • Quality assurance through reliability and installation standards

For such systems to have broad marketability, performance and reliability must be maintained or improved. Performance can be maintained relative to existing designs using selective coatings and optimizing component sizing. By transitioning to cold-climate thermosiphons without pumps or controllers, reliability will be improved relative to conventional forced-circulation systems. Incorporating solar heat with HPWHs to boost HPWH performance is also an option for future innovation. Technical barriers such as protection from stagnation and freeze conditions need well-engineered solutions to ensure reliable and safe operation. Extensive testing, including materials testing and accelerated component and system durability testing, is also required.

Figure ES–6 displays a possible pathway scenario to achieve a low-cost SWH design. In this figure, the base case is assumed to be a two-tank glycol system with a doubly pumped external heat exchanger. The highest system cost is for the baseline system, shown at the far left of the graph. The costs in this graph represent the installed cost of the system, including direct materials and labor, overhead/profit, marketing, and operations and maintenance (O&M). Reading left to right, the balance of system (BOS) variations are shown first, followed by the collector variations. The BOS changes are cumulative, and remain in for the collector substitution. In this example, cost reduction comes mainly from the use of polymer-based components, particularly collector, piping, and storage, with cost reduction percentages (savings values) of 12% (\$700), 14% (\$800), and 18% (\$1000), respectively. This analysis suggests that the program should first fund research to develop low-cost versions of collectors, tanks, polymer heat exchangers, and polymer piping, as they have the largest impacts on system cost.

System Cost, Savings Cost Glycol

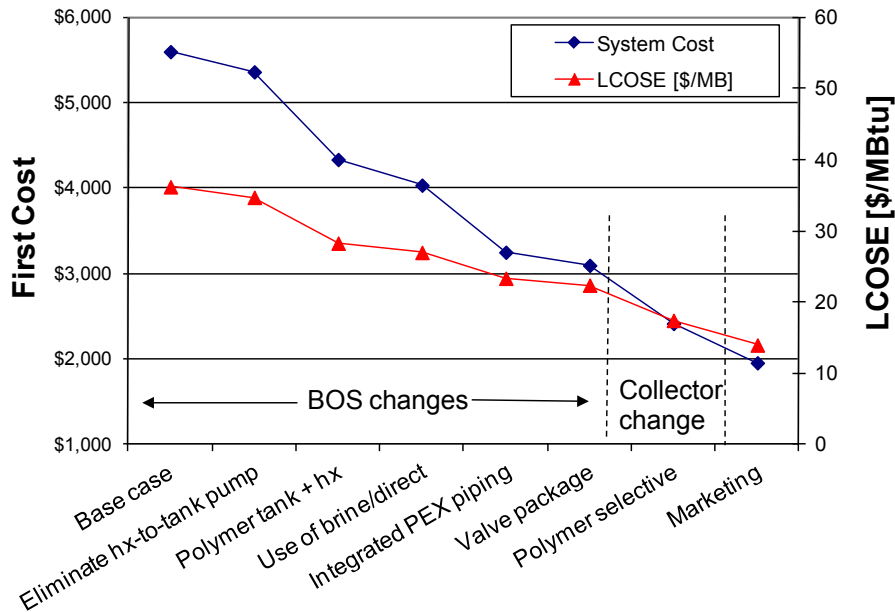

Burch 2004

Figure ES-6. Potential SWH cost reduction R&D pathway

The costs in Figure ES-6 are for a new construction scenario with direct volume purchase, efficient installation, zero permitting cost, and low marketing. These assumptions provide costs on the low end of today's range, and polymer substitution is unlikely to result in installed costs that meet the targets in this roadmap. Therefore, it is proposed that more radical designs also be explored as pathways to low cost. Another pathway option presented in this roadmap is a polymer film thermosiphon design. It is believed that with the correct level of R&D, an innovative thermosiphon design could result in a low-cost SWH system that is in line with the goals of this roadmap.

Research and Development Plan for Low-Cost SWH

R&D is essential to the success of low-cost SWH systems that can compete with natural gas water heating options in cold climates. Figure ES-7 shows the overall project timeline and the R&D targets broken down into three categories: Equipment, Optimized System Design and Advanced Operation & Maintenance, and Policy & Markets.

Successful completion of the R&D plan will lead to the development of one or more low-cost SWH systems that can compete with natural gas WHs in cold climates. This R&D is best performed through industry partnerships, where industry can lead the design efforts with technical support from DOE.

Additional reference materials for SWH technologies, including content from a low-cost SWH webinar that took place in July 2011, can be found at <https://sites.google.com/site/solarhotwaterinnovation/>

LOW-COST SOLAR WATER HEATING PROJECT TIMELINE

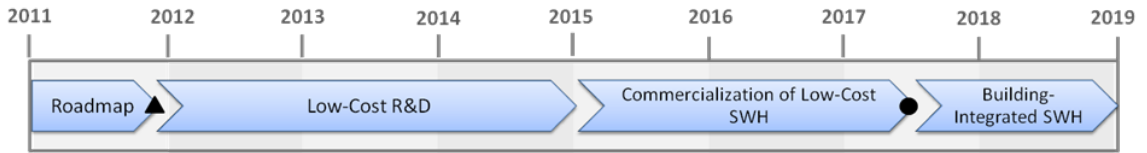

R&D TARGET 1: EQUIPMENT

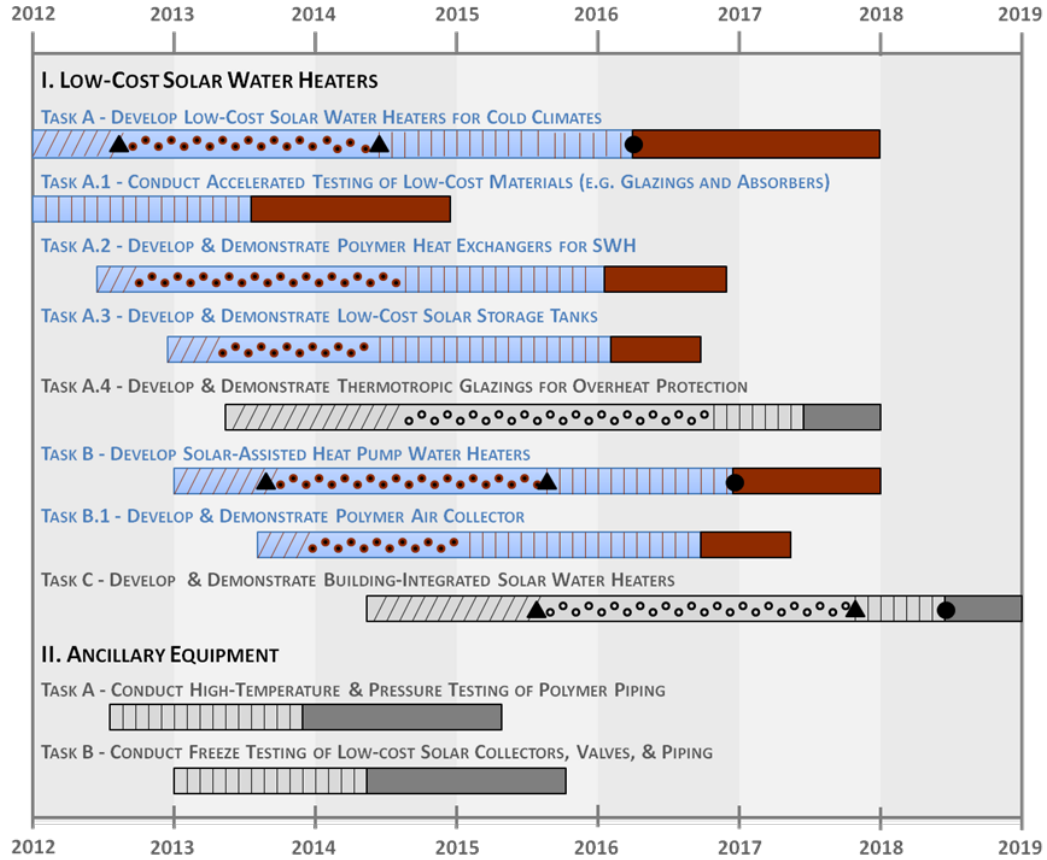

LEGEND	
TIMELINE	PRIORITY RATING
Feasibility/Business Case	High-priority activity
Design & Development	Lower-priority activity
Testing & Validation	Key Decision Point
Field Testing & Commercialization	Key Milestone

R&D TARGET 2: OPTIMIZED SYSTEM DESIGN, ADVANCED OPERATION & MAINTENANCE

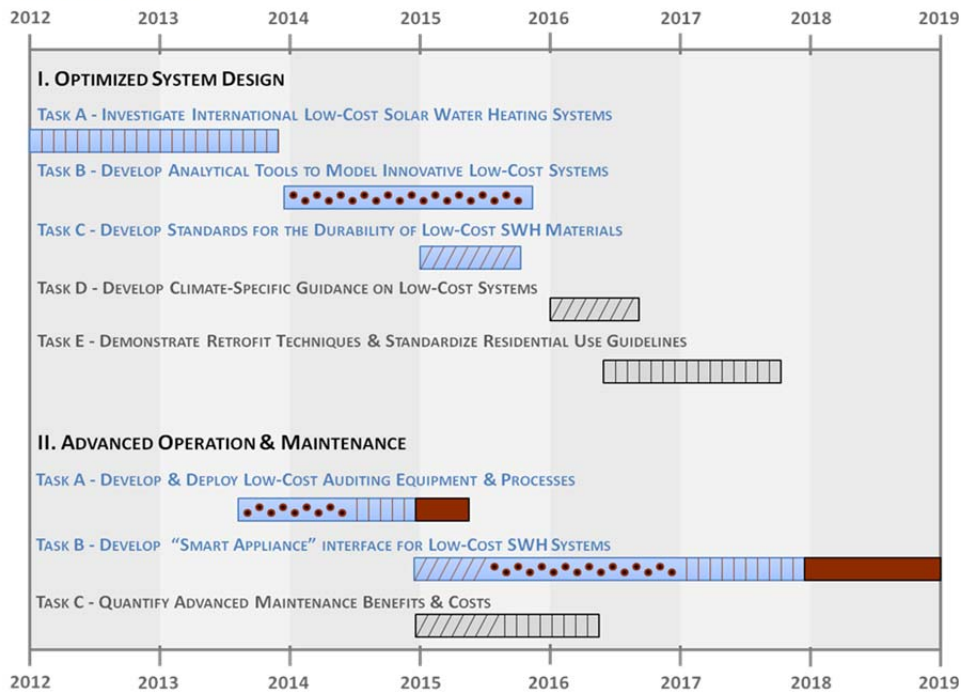

R&D TARGET 3: POLICY & MARKETS

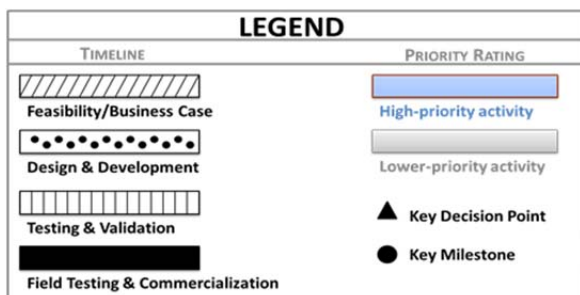
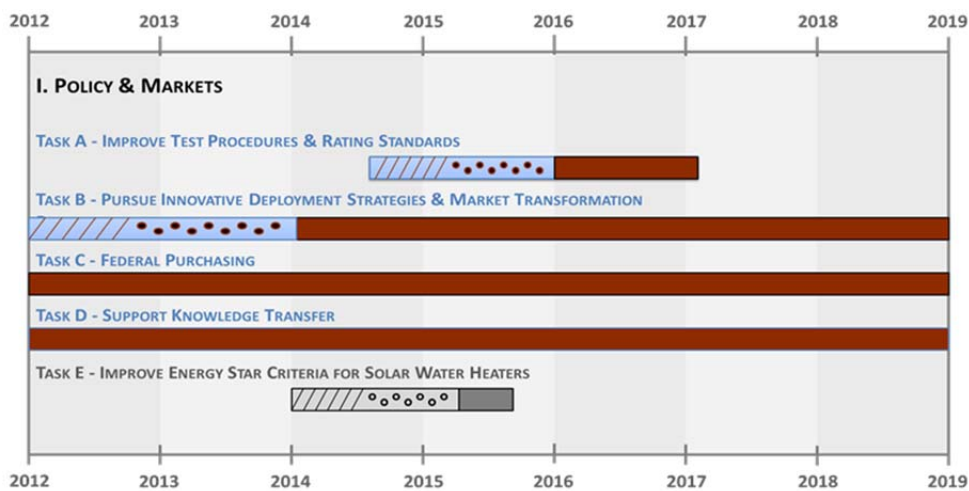

Figure ES-7. Residential low-cost SWH research activity—project and R&D timelines

Nomenclature

AEO	Annual Energy Outlook
BOS	balance of system
BTP	Building Technologies Program
Btu	British thermal unit
COP	coefficient of performance
DOE	U.S. Department of Energy
EERE	Office of Energy Efficiency and Renewable Energy
EF	energy factor
FPV	freeze protection valve
ft ²	square foot, square feet
gal	gallon
GPRA	Government Performance and Results Act
GW	gigawatt
HPWH	heat pump water heater
HX	heat exchanger
ICS	integral collector-storage
kWh	Kilowatt-hour
NREL	National Renewable Energy Laboratory
O&M	operations and maintenance
PB	polybutylene
PC	polycarbonate
PE	polyethylene
PEX	cross-linked polyethylene

PP	polypropylene
PPI	Producer Price Index
PV	photovoltaic
R&D	research and development
SRCC	Solar Rating and Certification Corporation
SWH	solar water heater, solar water heating
tcf	thousand cubic feet
TIO	technology improvement opportunity
TWh	terawatt-hour
UV	ultraviolet
WBS	work breakdown structure
WH	water heater

1 Introduction

U.S. residential and commercial buildings account for 40% of the total primary energy consumption of almost 100 quadrillion Btu (quads). Figure 1 shows how energy is used in U.S. residential buildings (DOE 2011a). Over the last 20 years, federal and state energy efficiency standards have helped reduce the energy consumption for residential space heating; however, air conditioning and water heating energy consumption have grown along with appliances and electronics (EIA 2009). Solar thermal energy has historically been associated with water heating, which is the second-largest end-use energy demand in the residential sector and the sixth-largest in the commercial sector.

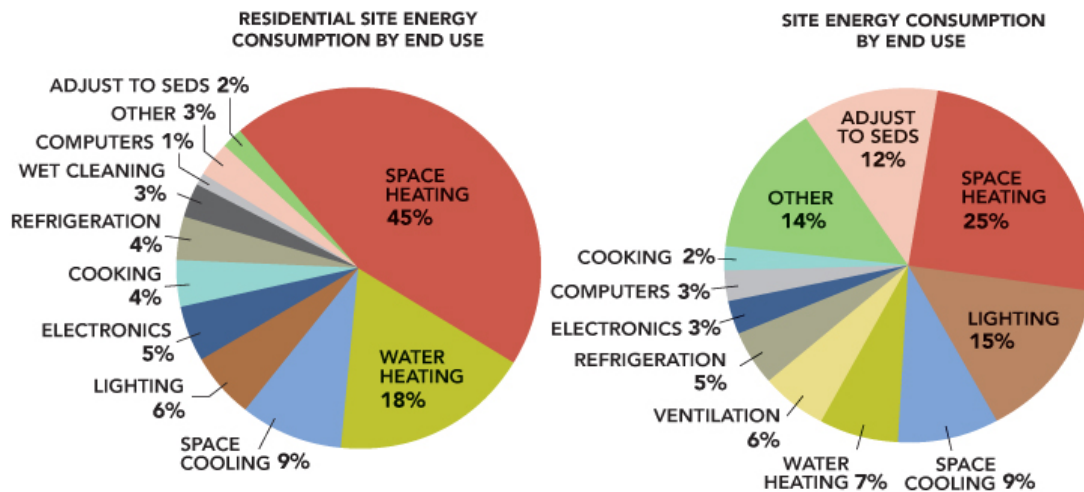

Figure 1. 2008 building energy end-use splits for residential (left) and commercial (right) buildings

Solar water heaters (SWHs) use energy from the sun to directly or indirectly (using a heat-transfer fluid) heat water. This technology is well understood and can contribute significantly to meeting U.S. energy and environmental goals, as SWHs generate clean primary energy with the potential to displace natural gas and electricity in all climates. The source energy savings potential of U.S. SWH alone is more than 1 quadrillion Btu (quad), which corresponds to an emissions reduction potential of approximately 1% of total U.S. annual carbon dioxide emissions (Denholm 2007). This is estimated by multiplying the total energy consumption for water heating by the number of available rooftops (estimated at approximately 50% of the housing stock) and the solar fraction (which is the percent of the annual hot water load met by solar) (EIA 2009).

To maximize the benefit of SWH, technology should be developed that has the potential to have broad market impacts. Based on analysis that will be presented in Section 2.2, the greatest opportunity for expanding the SWH market is to develop technology that is cost competitive with natural gas water heaters (WHs) in cold climates.

High-quality SWH systems can already meet the hot water demand for a typical household. The major barrier to achieving significant market acceptance in the near future, however, is the installed cost of an SWH system, which is affected by component costs

and “soft” costs such as labor and marketing. Research and development (R&D) is needed to lower the installed cost of SWHs to the U.S. homeowner and achieve the U.S. Department of Energy’s (DOE) energy savings and environmental goals. Also, the “soft” costs must be addressed as technical R&D is underway. Consumer awareness in the form of utility incentive programs and educational seminars can help inform the U.S. population of the benefits of SWH systems. In addition, installation needs to be simplified and more laborers need to be trained.

This roadmap reflects the results of this analysis and focuses on the development of SWH technology that will result in a near-term, low-cost solution with broad market impacts.

1.1 U.S. Department of Energy Goals

The DOE mission is to ensure U.S. security and prosperity by addressing its energy, environmental, and nuclear challenges through transformative science and technology solutions (DOE 2011d). DOE has four strategic goals for achieving its mission. Of these, the following aligns best with the low-cost SWH R&D activity:

Catalyze the timely, material, and efficient transformation of the nation’s energy system and secure U.S. leadership in clean energy technologies.

Under this goal, the DOE strategic plan (DOE 2011e) addresses the following specific target for the United States that also aligns with the low-cost SWH R&D activity:

Reduce energy-related greenhouse gas emissions by 17% by 2020 and 83% by 2050, from a 2005 baseline.

The low-cost SWH R&D activity falls under the Emerging Technologies subprogram of the Building Technologies Program (BTP) in the DOE Office of Energy Efficiency and Renewable Energy (EERE). Listed below are the goals of EERE, BTP, and the low-cost SWH R&D activity.

1.1.1 Office of Energy Efficiency and Renewable Energy

EERE supports research, development, demonstration, and deployment activities on technologies essential for meeting national security goals by reducing dependence on oil, meeting environmental goals by minimizing the emissions associated with energy production and use, and stimulating economic growth and job creation by minimizing the cost of energy services and stimulating investment in U.S. businesses (DOE 2011b).

The EERE mission is to strengthen U.S. energy security, environmental quality, and economic vitality through public-private partnerships that:

- Enhance energy efficiency and productivity.
- Bring clean, reliable, and affordable energy production and delivery technologies to the marketplace.
- Make a difference in the everyday lives of Americans by enhancing their energy choices and their quality of life (DOE 2011b).

1.1.2 Building Technologies Program

BTP's central vision is to significantly improve the efficiency of existing and new buildings by developing conservation technologies, strategies, and practices. The strategic goal focuses on developing cost-effective solutions that enable easy adoption in the marketplace for commercial buildings and residences.

The BTP mission is:

To develop technologies, techniques, and tools for making residential and commercial buildings more energy efficient, productive, and affordable. This involves research, development, demonstration, and deployment activities in partnership with industry, government agencies, universities, and national laboratories. The portfolio of activities includes improving the energy efficiency of building components and equipment and their effective integration using whole-building system design techniques. It also involves the development of building energy codes and equipment standards as well as the integration of renewable energy systems into building design and operation (DOE 2011d).

The low-cost SWH activity directly addresses “the integration of renewable energy systems into building design and operation” in BTP's mission.

1.1.3 Low-Cost Solar Water Heating R&D Goals

The overall objective of the low-cost SWH R&D activity is to target the large residential hot water markets in cold U.S. climates and contribute 35%–40% in cost-effective source energy savings that cannot be provided by conventional gas or electric HPWH technologies. A factor of three to five reduction in SWH cost, without compromising durability or performance, is needed to transform this market, especially in cold climates where natural gas is the predominant fuel for water heating.

The project's proposed technical approach is to work with industry partners to develop innovative low-cost SWH system designs that have compelling cost and performance characteristics, can be readily scaled up to volume production, and can have accelerated broad market impacts.

The activity has set the following cost, performance, and reliability targets:

- \$1,000–\$3,000 total installed SWH system cost in existing homes at large market scale
- Maintain conventional SWH systems' 35%–40% source energy savings over conventional natural gas WHs in cold climates
- 15–25 year product lifetime with high system and component reliability and performance.

If these targets for cold climate SWHs can be met, significant savings in energy use, utility bills, and carbon can be achieved that cannot currently be provided by other water heating technologies.

1.2 Roadmap Objective

This report focuses on the natural gas market segment in cold climates and outlines a near-term strategy to reduce the installed system costs and maintain the overall energy savings associated with SWH technology. It provides a guide for BTP as it refocuses its SWH R&D efforts. The activities the roadmap outlines will complement other water heating technologies, such as HPWHs, and can have accelerated broad market impacts in the primary market that is expected to offer the largest opportunity: water heating in cold climates where natural gas is the primary water heating fuel type. This roadmap is being coordinated with the development of DOE's *Advanced Water Heating R&D Roadmap*.

1.3 Roadmap Development Process

On July 28, 2011, the National Renewable Energy Laboratory (NREL) hosted a webinar to initiate the development of a *Low-Cost Solar Water Heating R&D Roadmap*. The purpose was to invite feedback from key participants in the residential water heating industry to review the gaps and barriers that currently limit the development of innovative low-cost SWH solutions.

During this webinar, a market and economic analysis was presented and example pathways to low-cost SWH systems were discussed. These pathways included examples from international markets as well as detailed pathway options that demonstrate the scale of innovations required to address current market and technical barriers. A significant portion of this webinar was used to review feedback about low-cost SWH and its applicability in cold climates. Content from the webinar, including the feedback and additional reference materials for SWH technologies can be found at <https://sites.google.com/site/solarhotwaterinnovation/>

This R&D roadmap reflects the feedback received from industry during and after the webinar. Direct industry feedback can be found in Section 5.4.

2 Technology and Market Status

2.1 Solar Water Heating Technology

SWHs use radiation from the sun to heat solar collectors, and then transfer that heat to water. As in conventional storage tank water heating systems, SWH systems also store the heated water for future use. Because hot water demand is typically greater in the morning or late evening and does not coincide with times of maximum solar radiation, an SWH system is normally supplemented with a conventional system that provides additional heating as necessary.

Most residential SWH systems contain five basic components:

- Solar thermal collector(s)—flat-plate and evacuated tube collectors are the most typical.
- Storage system—to meet the thermal energy demand when solar radiation is not available.
- Heat transfer system—piping and valves for liquids; pumps, fans, and heat exchangers (HXs), if necessary.
- Control system—to manage the collection, storage, and distribution of thermal energy.
- Auxiliary storage tank—to provide supplemental heat when solar energy is not sufficient to meet demand. This is typically a conventional electric resistance or natural gas storage tank WH.

A typical flat-plate solar collector (Figure 2) is mounted on a roof. It consists of a black metal absorber plate in an aluminum housing with a glass cover plate. Evacuated tube collectors (Figure 3) have a row of glass tubes that may contain small metal pipes that act as heat absorbers. Solar collector technology is described in more detail in Appendix A.



Figure 2. Flat-plate collector

Christopher Drake, NREL/PIX 09188



Figure 3. Evacuated tube collector

Alan Ford, NREL/PIX 09501

SWH systems can be either active or passive. Active SWHs are more common in the United States and rely on electric pumps and controllers to circulate water or heat transfer fluids through the collectors. There are two primary types of active systems:

- Indirect forced circulation SWHs (Figure 4) use pumps to circulate heat transfer fluids through the solar collectors. HXs transfer the heat from the fluid to the domestic water supply. These types of systems are currently used in areas where freezing temperatures occur.
- Direct circulation systems use a pump to circulate water directly through the collectors and into the storage tank for use in the building. These types of systems are currently used in climates that do not experience freezing temperatures, such as Hawaii, south Florida, and Puerto Rico.

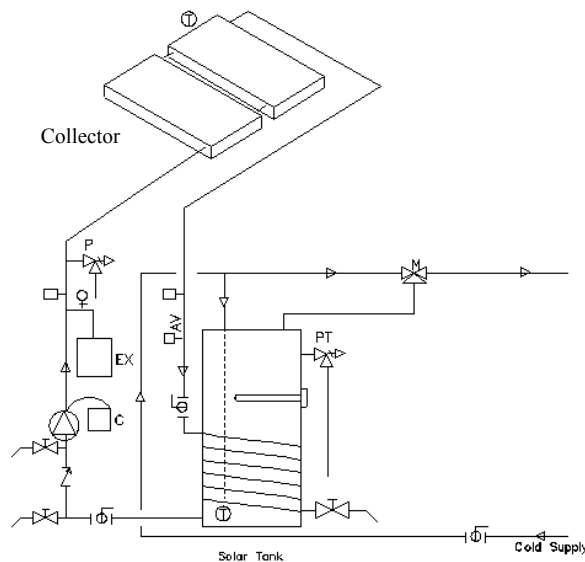

Figure 4. Diagram of an indirect forced circulation SWH system

SRCC 2001, used by permission

As with active systems, passive SWH systems can be direct or indirect. The two basic types of passive systems are integral collector-storage (ICS) systems and thermosiphon systems. ICS systems use building water pressure to move water through the collector. Thermosiphon systems allow water to circulate naturally as it is heated, rather than requiring mechanical pumps. Because passive systems have no electrical components, they are generally less expensive, more reliable, and easier to maintain than are active systems. Some types of passive systems are designed for use in freezing climates, although more often they are used in climates that do not experience freezing temperatures.



Figure 5. Commercial SWH system – IKEA Orlando

NREL/PIX 18711

SWH systems used for commercial buildings are similar to the systems described above. The primary difference is scale and some minor technical modifications, e.g., accommodating expansion and contraction in fluids and piping. Figure 5 displays a collector array supplying hot water to the cafeteria of an IKEA store in Orlando. Other typical commercial SWH applications include:

- Commercial laundries
- Car washes
- Hotels
- Hospitals
- Restaurants
- Correctional facilities
- Breweries and wineries (DOE 2011c).

2.2 Performance and Economics

Conventional electric resistance and natural gas-fired storage tank-type WHs heavily dominate the residential water heating market today. Other commercially available water heating technologies include conventional propane and oil-fired WHs, and advanced, high-performance WHs, including HPWHs, electric- and gas-fired tankless units, and high-efficiency, condensing natural gas WHs.

2.2.1 Performance Comparisons

HPWHs are an emerging technology that uses a refrigerant-based vapor compression cycle to absorb energy from the surrounding air and transfer it to water in an attached storage tank. This type of system currently has an energy factor (EF) rating of 2.0–2.5. The EF describes the efficiency of the WH and takes into account recovery after draws and standby losses. It is a standard used to compare the efficiencies of various types of WHs and is defined by a DOE test procedure (DOE 1998). The EF of HPWHs is expected to increase in the near future as a result of design improvements and changes to refrigerant type. For reference, the EF of an electric resistance WH is around 0.9 and the EF of a natural gas WH is 0.6. Although the efficiency of a HPWH depends on the temperature of the surrounding air and the water in the storage tank, laboratory experiments have shown that HPWH technology has an annual coefficient of performance (COP) of at least 2.0 (Sparn et al. 2011). The COP is defined as the useful energy transferred to the water divided by the input energy to the system.

A schematic of an HPWH is shown in Figure 6. HPWHs have backup electric resistance elements in the storage tank that are enabled when the hot water demand cannot be met with the heat pump alone. This situation can occur because the recovery time of an HPWH operating with the heat pump alone is significantly longer than conventional methods of heating water.

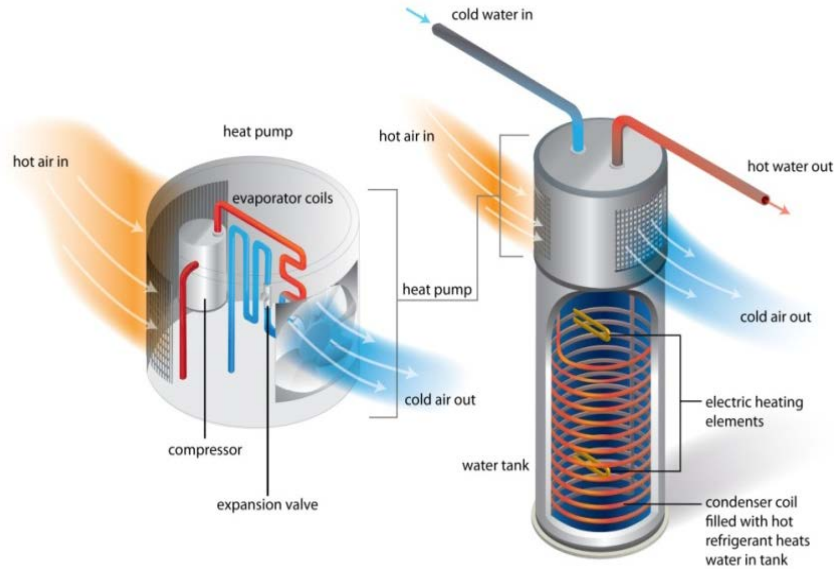

Marjorie Schott/NREL

Figure 6. Schematic of HPWH technology

HPWHs are a promising new technology that competes directly with SWHs. It is therefore essential to understand which segment of the market is best suited for HPWHs and focus the development of innovative, low-cost SWHs in the market segment with the largest opportunities.

Annual energy simulations were run using TRNSYS, and analysis was performed to compare the energy savings associated with HPWH and SWH technologies to conventional methods of water heating. Figure 7 shows the annual source energy savings for HPWH and SWH technologies compared to a conventional electric resistance WH. Details of this analysis can be found in Appendix B.

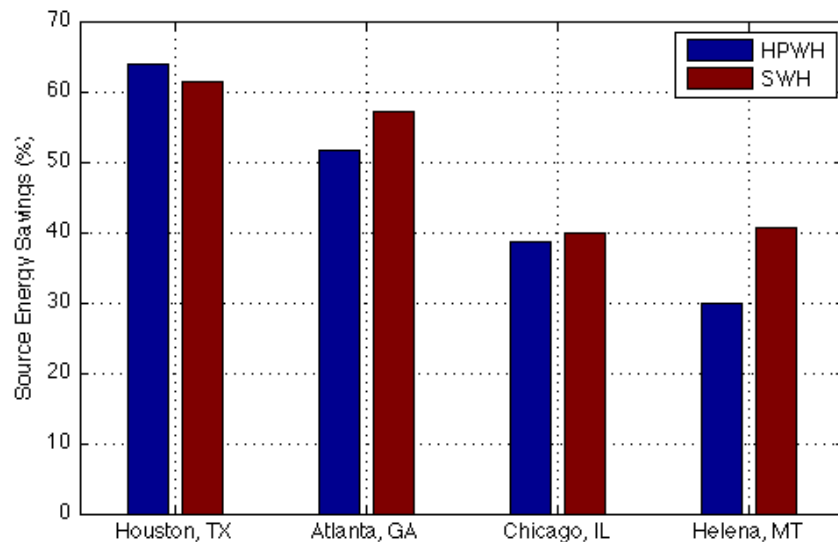

Figure 7. Annual source energy savings for HPWH and SWH technologies versus conventional electric resistance WHs

This analysis shows that HPWHs and SWHs will save significant annual source energy over electric resistance WHs, regardless of location. The energy savings between the technologies is similar, so a homeowner could choose either. Because of the annual savings that can be achieved using an HPWH, this technology will be required by law to replace electric resistance WHs larger than 55 gal starting in 2015 (DOE 1998).

The comparison with conventional natural gas WHs tells a different story. Figure 8 shows the annual source energy savings for HPWH and SWH technologies compared to a conventional natural gas WH. Because the site-to-source ratio for electricity is significantly greater than natural gas (3.365 versus 1.092, respectively) (Hendron and Engebrecht 2010), replacing a conventional natural gas WH with an HPWH results in negative annual source energy savings in all locations shown except Houston, Texas. In contrast, SWHs save significant source energy relative to a conventional natural gas WH regardless of location.

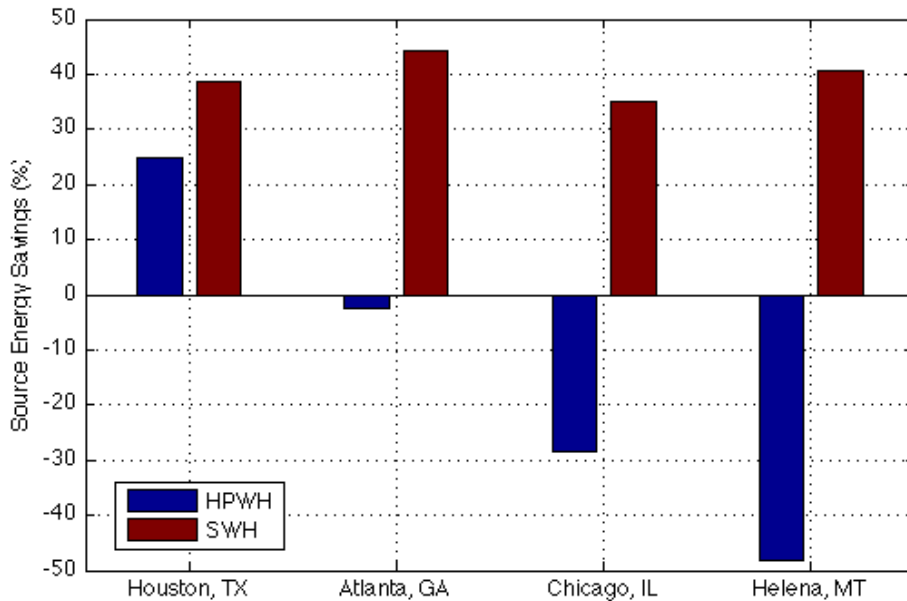

Figure 8. Annual source energy savings for HPWH and SWH technologies versus conventional natural gas WHs²

This result is emphasized in Figure 9, which shows the locations that would result in positive source energy savings if a HPWH replaces a conventional natural gas WH. As shown in red, the region with positive energy savings is confined to a narrow market in the hot climates of the southern United States.

² SWH source energy savings is displayed in kilowatt-hours for easy comparison to HPWH technology. This “equivalent kilowatt-hours” was calculated using the following conversion: 1 therm = 29.3 kWh.

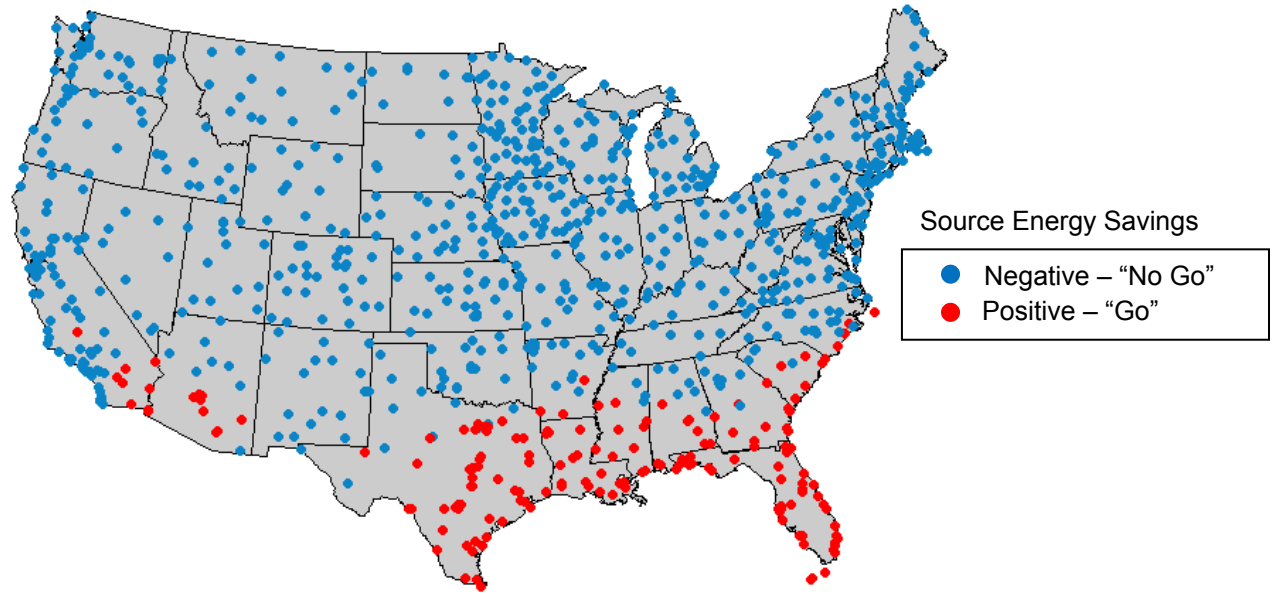

Figure 9. “Go/no go” annual source energy savings for an HPWH versus gas WH in conditioned space, furnace/AC case

The results show that SWH technology must be competitive with conventional natural gas WHs to have broad market impacts. A summary of this analysis is shown in Table 1 for the four locations analyzed in this study.

Table 1. Annual Source Energy Savings for HPWH and SWH Technologies Versus Conventional Natural Gas and Electric Resistance Water Heating

Location*	HPWH Versus Gas (% Savings)	SWH Versus Gas (% Savings)	HPWH Versus Electric (% Savings)	SWH Versus Electric (% Savings)
Zone 1 – Houston, TX	24.9%	38.8%	63.8%	61.4%
Zone 1 – Atlanta, GA	-2.6%	44.1%	51.7%	57.2%
Zone 2 – Chicago, IL	-28.3%	35.0%	38.7%	39.9%
Zone 3 – Helena, MT	-48.3%	40.7%	29.8%	40.7%

*The zones correspond to those shown in Figure B-1.

In Figure 9, the locations in blue represent the greatest market opportunity for SWHs. This closely corresponds to locations that have a high likelihood of experiencing freeze conditions at some point during the year, as shown in Figure 10.

Probability of at Least One Pipe Freeze in 20 Years

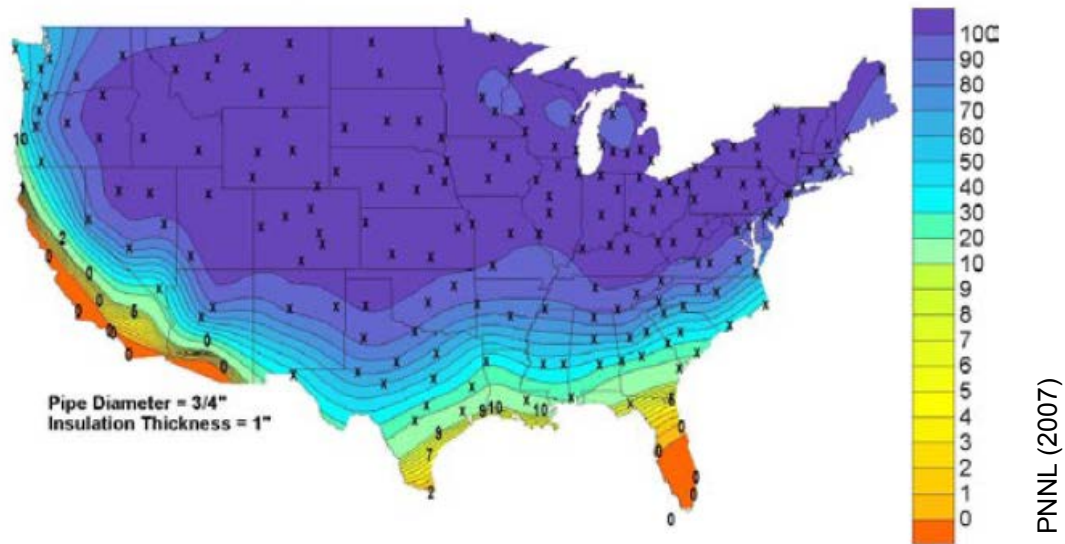

Figure 10. Freeze incident probability of an insulated copper pipe over a 20-year system lifetime

A separate study compares gas tankless WHs to conventional natural gas WHs and SWHs (Maguire 2011). This study was performed with similar TRNSYS models as in the previous analysis, except for some differences in the daily draw profiles and in the building models used to run the annual simulations. Despite differences in the draw profiles, the overall hot water demand is the same as in the previous analysis. The results are shown in Table 2 for WHs installed in the conditioned space of a building.

Table 2. Annual Source Energy Savings for Gas Tankless and SWH Technologies Versus Conventional Natural Gas Water Heating

Location	Tankless Versus Conventional Gas WH (% Savings)	SWH Versus Conventional Gas WH (% Savings)	SWH Versus Tankless (% Savings)
Chicago, IL	11.0%	37.5%	29.8%
Seattle, WA	6.1%	35.8%	31.6%
Atlanta, GA	17.8%	47.8%	36.4%
Los Angeles, CA	20.7%	46.6%	32.6%
Houston, TX	28.8%	34.7%	8.2%
Phoenix, AZ	32.2%	40.9%	12.9%

These results show that tankless WHs are up to 32% more efficient than conventional natural gas WHs, because tankless units do not have the standby losses associated with a conventional tank system. Thus, in addition to conventional gas WHs, SWHs also have to compete with gas tankless WHs in cold climates. The results in Table 2 show that SWHs will save about 30% source energy relative to tankless WHs in all locations with cold to mild climates. In the warmer climates of Houston and Phoenix, the savings between gas tankless and SWHs are less, but a benefit still results from using solar in these regions over

gas tankless. The comparison between SWHs and conventional natural gas WHs is also presented in this table, because the values are slightly different than those presented in Table 1. This is due to the differences in the simulations mentioned previously.

Based on the analysis presented in this section, the SWH activity should focus on innovative low-cost solutions that are applicable to cold climates. Such systems could be used in all U.S. locations; however, they need to be optimized for cold climates such that they yield sufficient savings to be worthwhile, and such that freezing conditions are not a concern for long-term durability in the target market. The other reason to focus on cold climates is that DOE and NREL have already developed, in collaboration with industry, simple and effective SWHs for regions that do not experience freeze conditions (Burch et al. 2005).

Competing with conventional natural gas WHs is also a promising target market for SWHs because, of the 110 million households in the United States that require fuel for water heating, 39% use electricity and 54% use natural gas (see Figure 11). Figure 12 illustrates the regional distribution of residential water heating fuel type for each of the nine census regions, as derived from the Energy Information Administration’s Residential Energy Consumption Survey (EIA 2011). Additionally, specific values are listed for the four most populous states (California, Texas, Florida, and New York). The pie charts indicate the percentage of households in each census region or state that use a given fuel type.

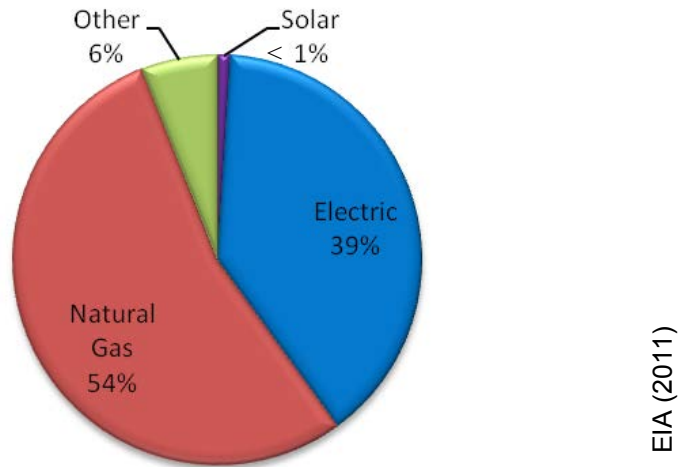

Figure 11. Residential and commercial WHs, % of units by energy source

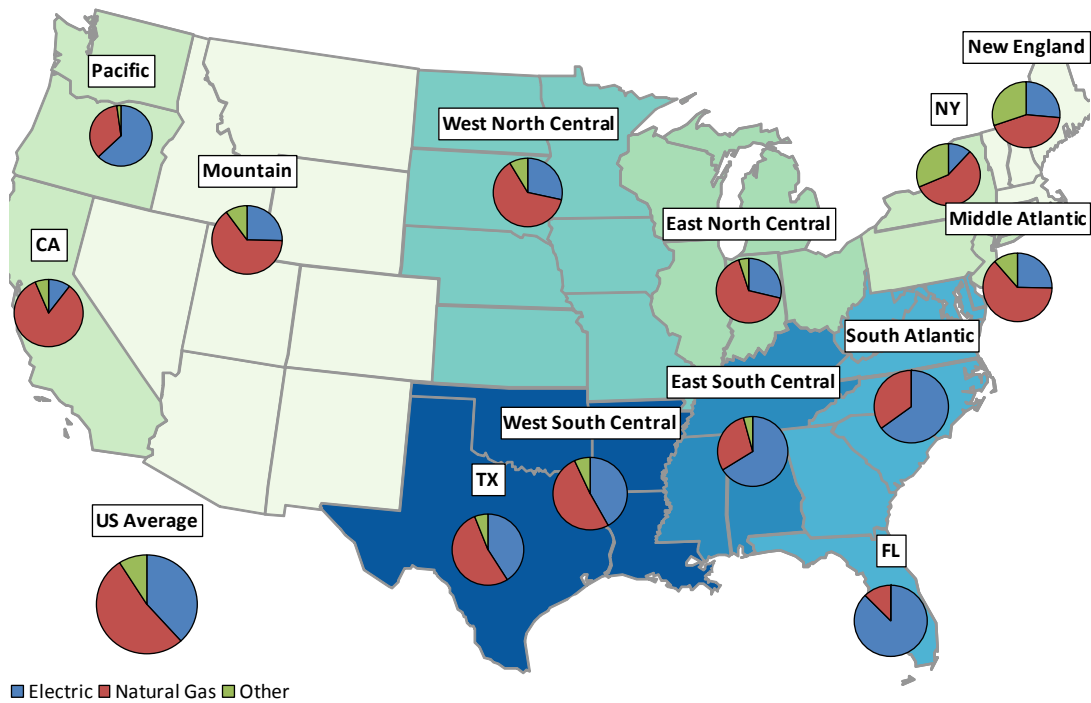

Figure 12. Regional distribution (by U.S. census region) of the number of houses using a particular water heating fuel type³

Natural gas is the most common water heating fuel type for most of the country, most notably in the Mountain region and California, where natural gas accounts for 68% and 85% of all water heating fuel consumption, respectively. The only regions where electricity is the most common water heating fuel type is in the Pacific Northwest (California excluded) and the Southeast. Even in the Northeast, where one fourth to one third of the residences use fuel oil (primarily in older residences), natural gas accounts for most water heating fuel consumption.

2.2.2 Solar Water Heater Economics

A typical residential SWH system produces 50–100 gal/day of hot water and costs \$6,000–\$10,000 installed before rebates and incentives; a conventional gas system costs \$600–\$1,350 (ACEEE 2006). The wide cost range for SWH systems results from the variety of technology types available for different applications and climates. Evacuated-tube collectors can be twice as expensive as flat-plate collectors. ICS systems have been the least expensive, as well as the simplest and most reliable SWH systems historically, but they are vulnerable to freezing and perform best in warmer climates.

A recent NREL study of residential SWH systems with natural gas backup in the United States found that for a \$7,000 SWH system capital cost, break-even conditions currently

³ Where a census region includes one of these large states, two pie charts are shown; one for the specific state, and another for the rest of the states in that region.

exist in only 0.04% of U.S. residences (Cassard et al. 2011a). If the system cost were reduced to \$2,500, this would increase the percentage of residences at break-even conditions to 50%. Additional reduction in cost to \$1,000 would result in 95% of the United States at break-even cost. Figure 13 shows the break-even costs for SWH systems with natural gas auxiliary WHs in the United States. Break-even conditions are defined as the point where the cost of SWH-generated energy equals the cost of a conventional heating fuel purchased from the grid (in this case, natural gas) (Cassard et al. 2011a). This is essentially the point at which the net present cost of the system (installation plus maintenance) is equal to its net present benefits (the value of reduced fuel expenditures plus any incentives).

Achieving SWH break-even cost is a function of many variables, including the solar resource, local gas prices, hot water use, and various incentives. As a result, for a country such as the United States, where these factors vary regionally, there can be considerable variation in break-even cost.

This study shows that the cost of SWH systems needs to decrease to less than \$2,500 to compete with natural gas in more than 50% of the United States. Further reducing the system cost to \$1,000 would make SWHs competitive in all U.S. regions. A significant increase in fuel prices would result in higher break-even costs. This study assumed a price escalation of 0.5%/year; however, this is an assumption and is subject to change.

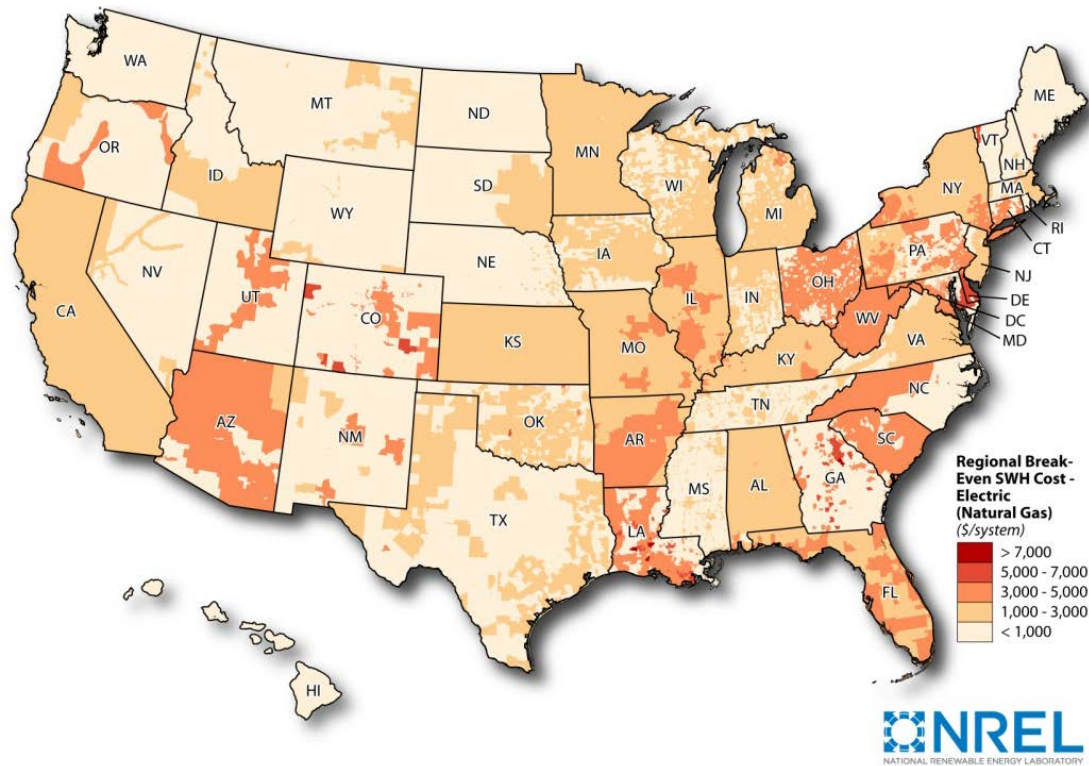

Author: Billy Roberts - September 22, 2010

This map was produced by the National Renewable Energy Laboratory for the U.S. Department of Energy.

Figure 13. Residential SWH break-even cost (\$/system) for the top 1,000 natural gas utilities (as of 2008) for an SWH with a natural gas auxiliary WH and using all incentives

Cassard et al. (2011a)

2.3 Domestic Solar Thermal Market

Almost 8 million residential WHs were sold in the United States in 2009. Figure 14 shows the split between residential gas and electric WH shipments from 1990 to 2009. One million residential shipments in 2009 were ENERGY STAR[®]-qualified WHs, most of which were in the high-efficiency gas storage WH category. Other ENERGY STAR-qualified WHs in 2009—the first year of the ENERGY STAR WH program—were tankless gas WHs, HPWHs, and SWHs.

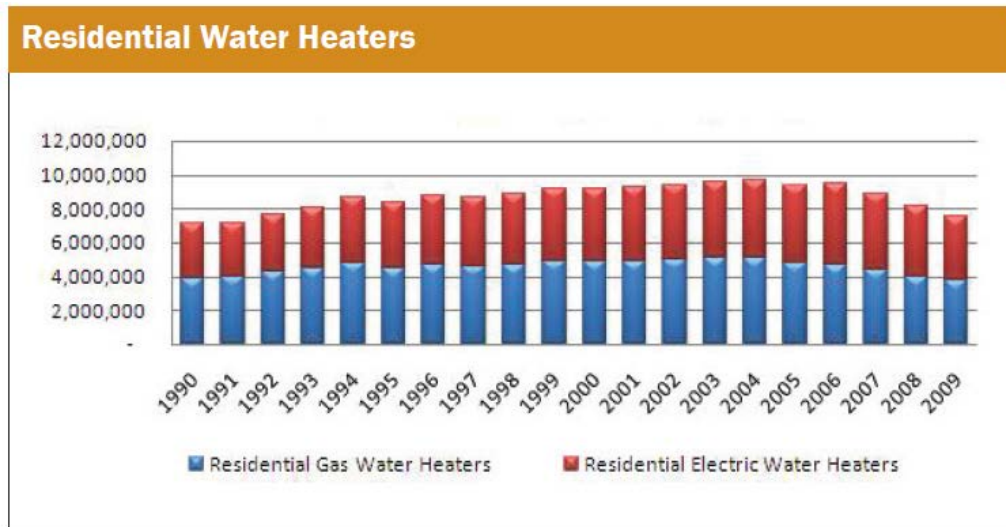

ACHI (2011), used by permission

Figure 14. U.S. residential WH shipments, 1990–2009

Figure 15 illustrates the number of SWH systems installed in the United States between 1974 and 2010. The 1970s and 1980s saw a significant national market for SWHs, partly in response to the energy crises and partly because a 40% federal income tax credit (capped at \$4,000), coupled with individual state incentives, was available from 1979 to 1985. Sales peaked at about 180,000 SWH systems in 1984, just before the end of federal tax credits, representing almost 2% of the total number of WHs installed that year. With the end of the federal incentives, the industry underwent a precipitous decline and has not since reached an annual WH market penetration rate of more than 0.4%.

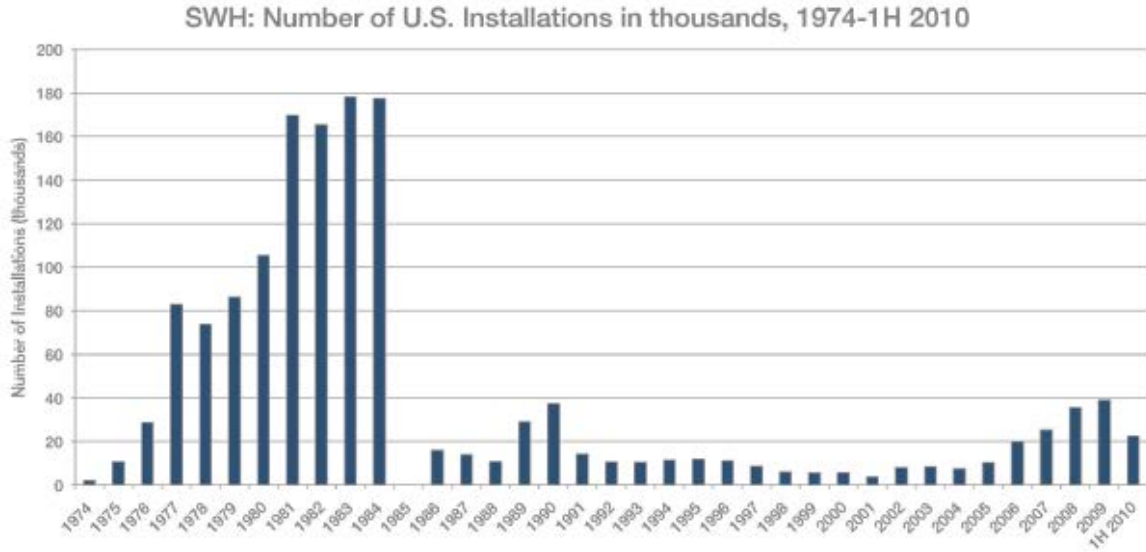

Figure 15. U.S. SWH system installations, 1974 to first half 2010

SEIA-GTM (2011), used by permission

The few U.S. solar collector manufacturers that survived the 1980s solar thermal market collapse kept the solar industry alive by making flat-plate solar collectors, ICS units, and polymer solar pool heating collectors. (Solar pool heating technology and market status are described in Appendix C.) The SWH collectors shipped dropped from more than 10 million ft² in 1985 to fewer than 1 million ft² in the 1991–2005 period. Production has recently increased again with passage of the federal investment tax credit in 2006.

Figure 16 displays the combined shipments of all solar thermal collectors (SWH and solar pool heating) in the United States from 1974 to 2008. Between 1992 and 2008, the compound annual growth rate was 6%. Between 1974 and 1980, the average annual U.S. growth rate was 33%, indicating the potential of the market and the industry to increase significantly.

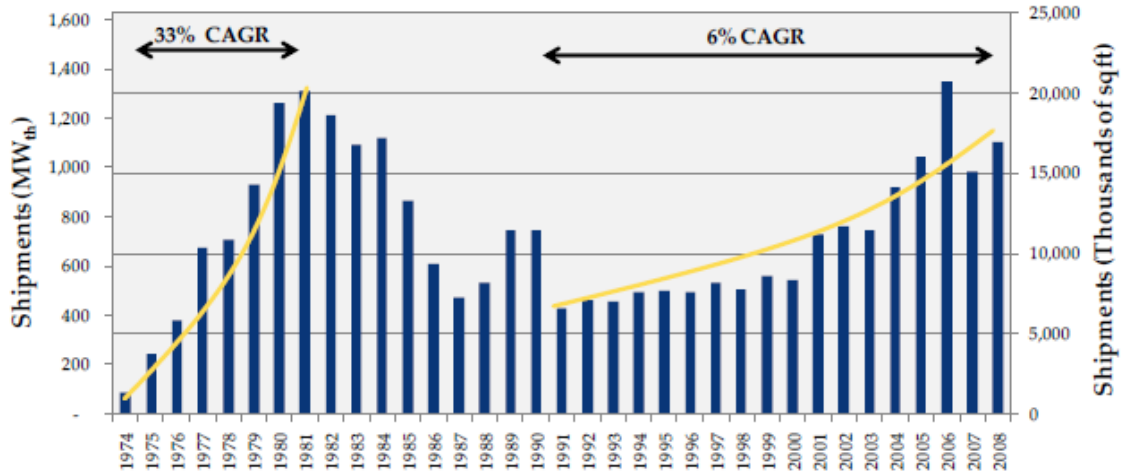
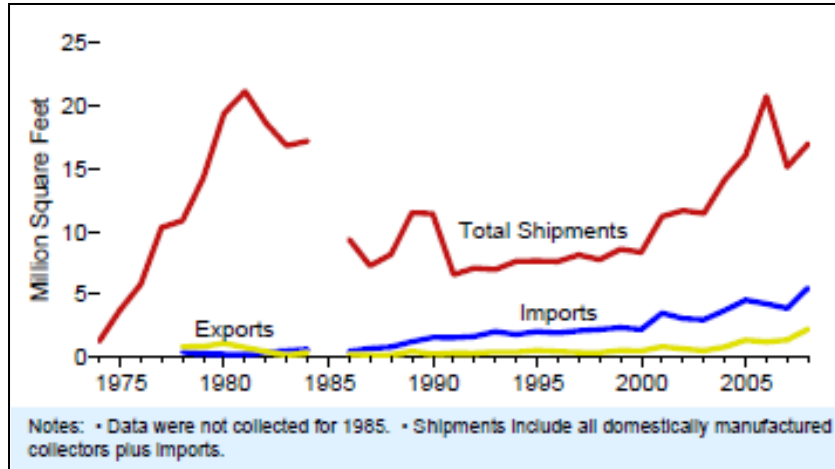

Figure 16. U.S. solar thermal collector shipments, 1974–2008

Navigant Consulting, Inc. (2010).
Used by permission

Figure 17 also displays the combined shipments of all solar thermal collectors (SWH and solar pool heating) in the United States between 1974 and 2008; however, imports and exports are also indicated. Imported collectors reached a record level of 5.5 million ft² in 2008.



EIA (2010b)

Figure 17. U.S. solar thermal collector shipments (including imports/exports)

The solar thermal industry has a long history in many regions of the United States. SWH once dominated the residential markets in Florida and southern California and is a significant market force in Hawaii today. Figure 18 shows the distribution of SWH collectors (in collector area) shipped to the top 10 states (including Puerto Rico) in 2010. Although this graph does not necessarily reflected the collector area that was installed in each state, it does reflect solar thermal demand. The California Solar Initiative – Thermal Program kicked off in May 2010, and enabled California to surpass Hawaii toward the end of 2010, especially as the housing downturn continued to affect Hawaiian homebuilders.

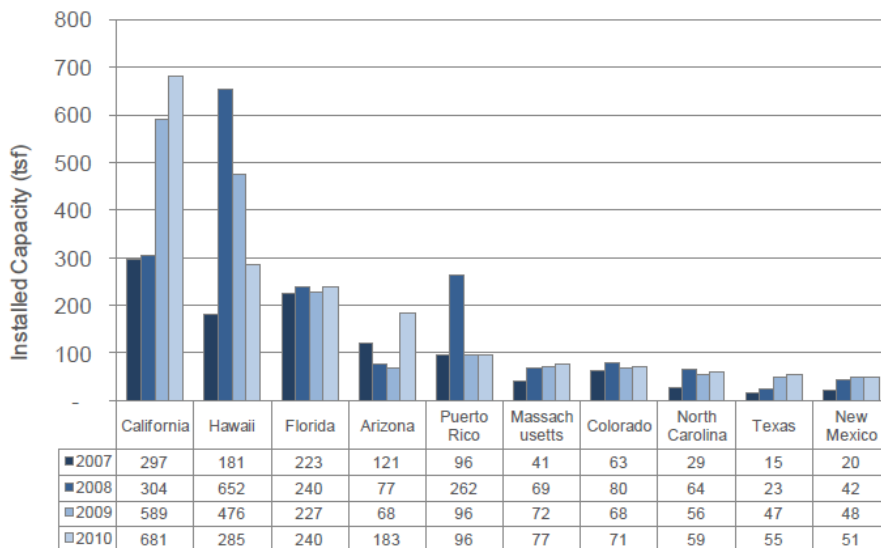

SEIA-GTM (2011), used by permission

Figure 18. SWH collector area shipments between 2007 and 2010 (1,000 ft²)

Figure 19 shows the SWH collector area shipped to the top 20 states in the first half of 2010. Four states—California, Hawaii, Florida, Arizona—and Puerto Rico currently dominate the U.S. SWH market.



Figure 19. First half 2010 SWH collector area shipped for the top 20 states

The limited use of SWH systems in the United States relates to the historically low cost of energy, particularly natural gas. Figure 20 displays the monthly average price of natural gas delivered to U.S. residential, commercial, and industrial consumers between 1981 and 2011. Residential prices peaked in 2008 at more than \$20/tcf, but dropped to half that in 2011. Industrial natural gas prices are approximately half those of average residential prices.

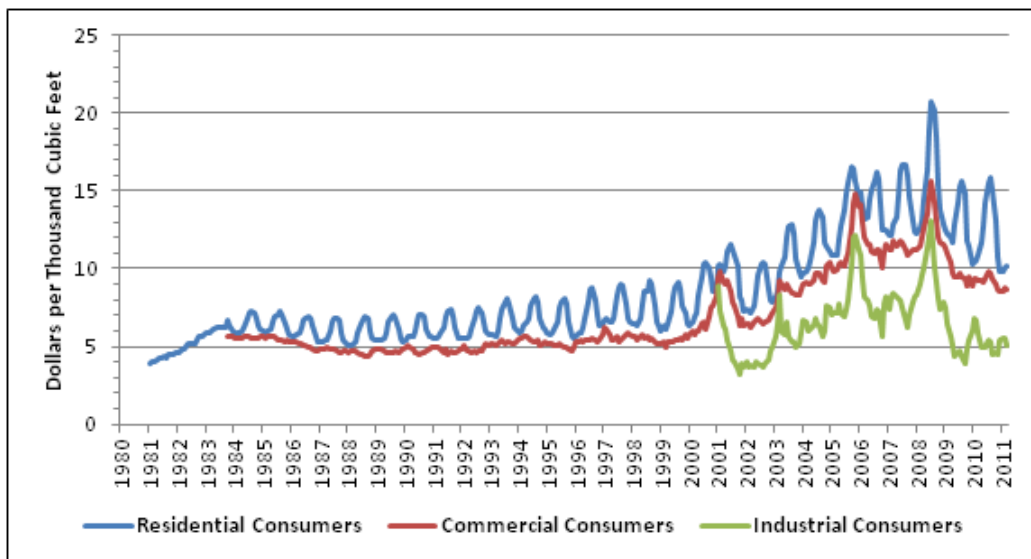

EIA (2011)

Figure 20. Monthly average price of natural gas delivered to U.S. residential, commercial, and industrial consumers, 1981–2011

Concerns about greenhouse gas emissions, natural gas supplies, and fossil fuel price volatility, along with lower costs and better performance from modern SWH systems, have revived interest in SWH technologies. However, as with photovoltaics (PV) and other renewable energy technologies, the SWH industry would benefit tremendously from consistent policies to accelerate and sustain SWH development, including research that addresses first-cost barriers.

The annual energy savings of an SWH system depend heavily on the local solar radiation. The Solar Rating and Certification Corporation (SRCC) lists the estimated annual performance of its listed residential SWH systems for various locations throughout the United States (SRCC 2011).

As shown in Section 2.2, a typical residential SWH system saves 35%–60% of a conventional system’s energy use. SWHs currently displace about 13 trillion Btu in electricity and natural gas each year, which combined exceeds the annual residential natural gas use in Delaware (EIA 2011).

2.3.1 Solar Water Heating Accomplishments

DOE’s SWH research and the U.S. SWH industry have made considerable progress in the advancement of SWH technologies over the last several years. Several significant SWH industry and DOE SWH R&D accomplishments follow:

- **More than 120,000 SWH systems installed between 2007 and 2010.** With the passage of the federal 30% investment tax credit for SWH systems in 2006, the number of SWH installations in U.S. states and territories has increased significantly. From 1991 to 2005, fewer than 10,000 SWH systems were installed in the United States each year. In the last three years, more than 30,000 SWH systems have been installed annually (see Figure 21).



SEIA (2011a), used by permission

Figure 21. U.S. SWH system installations, 2005–2010

- **10,000 polymer SWH systems installed.** NREL has worked with the largest U.S. solar pool heater manufacturer, FAFCO, Inc., to develop a low-cost SWH system. FAFCO introduced its polymer-based SWH system for warm climates at the International Builders Show in February 2007. In 2010, FAFCO reached more than 10,000 residential system installations, primarily through its pool heating

distribution network in Arizona and Florida. The polymer solar collectors (Figure 22) are similar to those used in its pool heating systems, with a proven lifetime exceeding 15 years.



Mike Rubio, FAFCO, used by permission

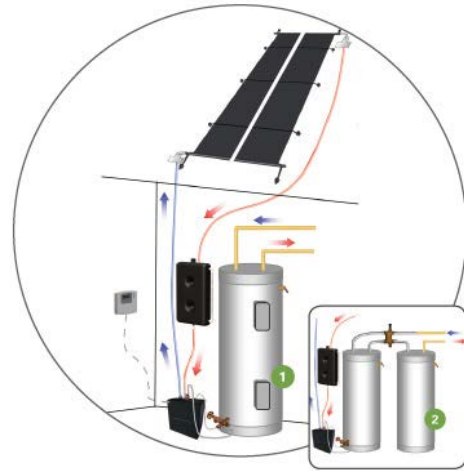

FAFCO (2012), used by permission

Figure 22. FAFCO polymer SWH collectors

Figure 23. FAFCO SWH system

Consumer Reports (2010) published the results of a year-long test of the FAFCO system in a review about SWHs and hybrid HPWHs. Even though the FAFCO system (Figure 23) was designed for installation in warm Sunbelt climates, it still provided an annual energy saving of 35% at the Consumer Reports test facility in Yonkers, New York. Based on its estimated range of installed costs for the FAFCO Sungrabber residential SWH system of \$2,500 to \$4,500, Consumer Reports concluded that “Sungrabber could pay for itself as quickly as a hybrid heater. [5-9 years payback with federal credit]”

- **SWH system on the White House.** In October 2010, Secretary of Energy Steven Chu and Council of Environmental Quality Chair Nancy Sutley announced plans to install a solar electric system and an SWH system on the roof of the White House residence (White House Blog 2010). These two solar installations will be part of a DOE demonstration project showing that American solar technologies are available, reliable, and ready for installation in homes throughout the country. “This project reflects President Obama’s strong commitment to U.S. leadership in solar energy and the jobs it will create here at home,” said Secretary Chu. “Deploying solar energy technologies across the country will help America lead the global economy for years to come (DOE 2010a).”

2.3.2 Competing Technologies

One barrier to U.S. market growth of SWH is the competition from other energy-efficient water heating technologies. New products, such as HPWHs, gas condensing, and gas tankless WHs, offer consumers energy-saving products that are more efficient than their current WHs at a more reasonable first cost than solar. Figure 24 shows the installed costs of the various types of water heating options. This graph shows that the up-front cost of an SWH system is significantly higher than other water heating methods. The gas-fired WH column includes the energy-efficient gas condensing and gas tankless WHs.

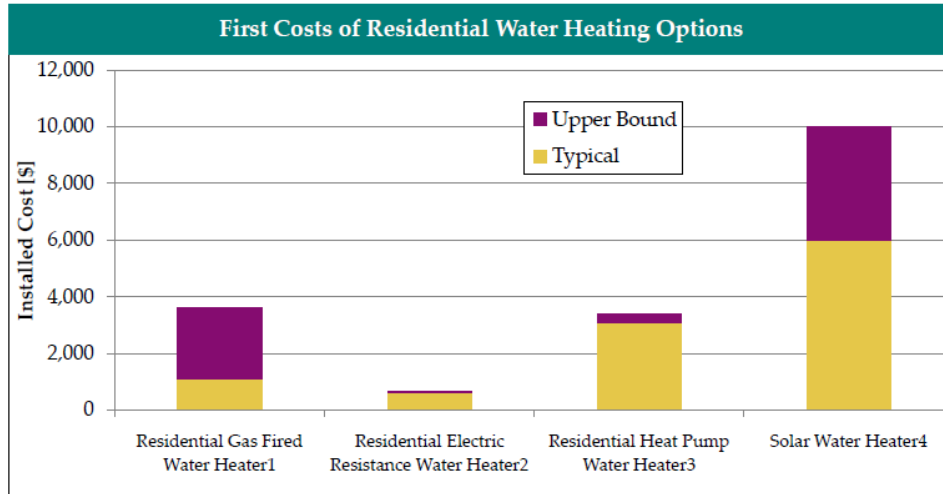

1. Source: EIA. Typical is 0.62 Energy Factor and Upper Bound is 0.85 Energy Factor. Both are 40 gallon capacity.
 2. Source: EIA. Typical is 0.92 Energy Factor and Upper Bound is 0.95 Energy Factor. Both are 50 gallon capacity.
 3. Source: EIA. Typical is 2.0 Energy Factor and Upper Bounds is 2.35 Energy Factor. Both are 50 gallon capacity
 4. Solar Water Heating costs from *Solar Hot Water Supply Chain Market Analysis*, October, 2010. Variations in price due to variations in system architecture. Cost shown is for a 40 gallon tank system before federal or local incentives.

Navigant Consulting, Inc.,
used by permission

Figure 24. First cost of SWH systems compared to other water heating methods

2.3.3 Global Solar Thermal Market

Figure 25 shows the significant energy contribution from solar thermal systems worldwide at 204 TWh in 2011. Solar thermal system capacity (245 GW) also exceeds the capacity of wind power (239 GW) and is far ahead of geothermal power (12 GW), PV (67 GW), and concentrating solar power (1.2 GW).

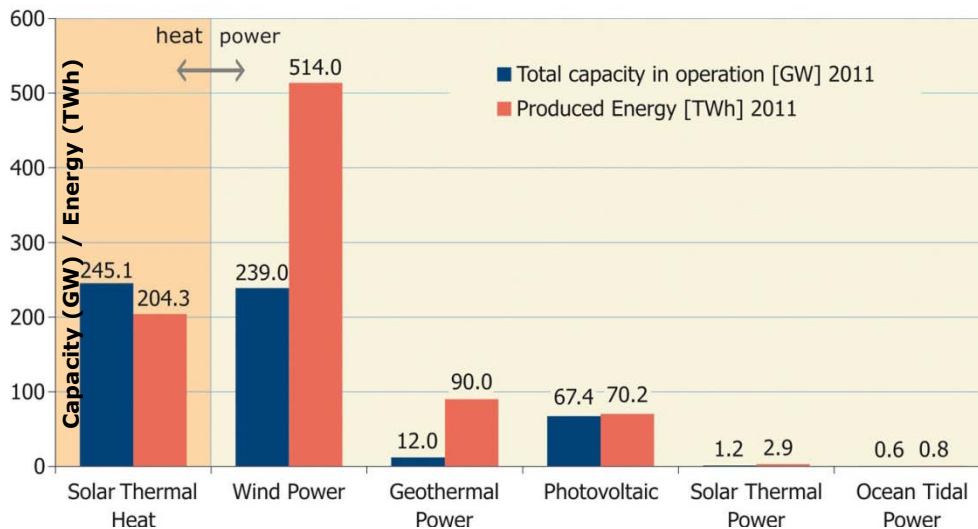

Weiss and Mauthner (2012),
used by permission

Figure 25. World renewable energy capacity and energy production, 2011

SWH technologies are playing an immense role in clean energy development globally; however, the U.S. SWH market lags far behind other countries, especially in proportion to population (the United States ranks between Poland and the United Kingdom), as shown in Figure 26. Figures 26 and 28 use the convention that was adopted by the International Energy Agency's Solar Heating and Cooling Programme of 0.7 kW-thermal/m² of solar

collector area (IEA 2011). The various types of solar thermal collectors—unglazed, glazed flat-plate, evacuated tube, etc.—are briefly described in Appendix A.

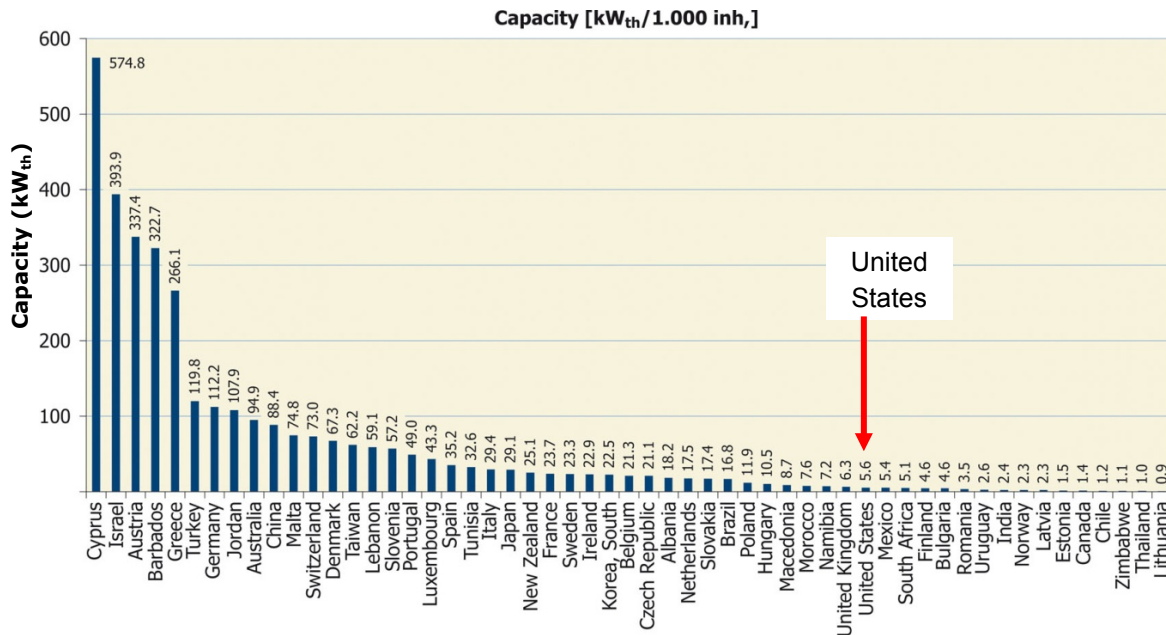

Weiss and Mauthner (2012),
used by permission

Figure 26. Glazed and evacuated tube collector capacity per 1,000 inhabitants, 2011

The global market can also be viewed in terms of collector installations by area. Figure 27 shows that China leads the market in terms of installed collector area.

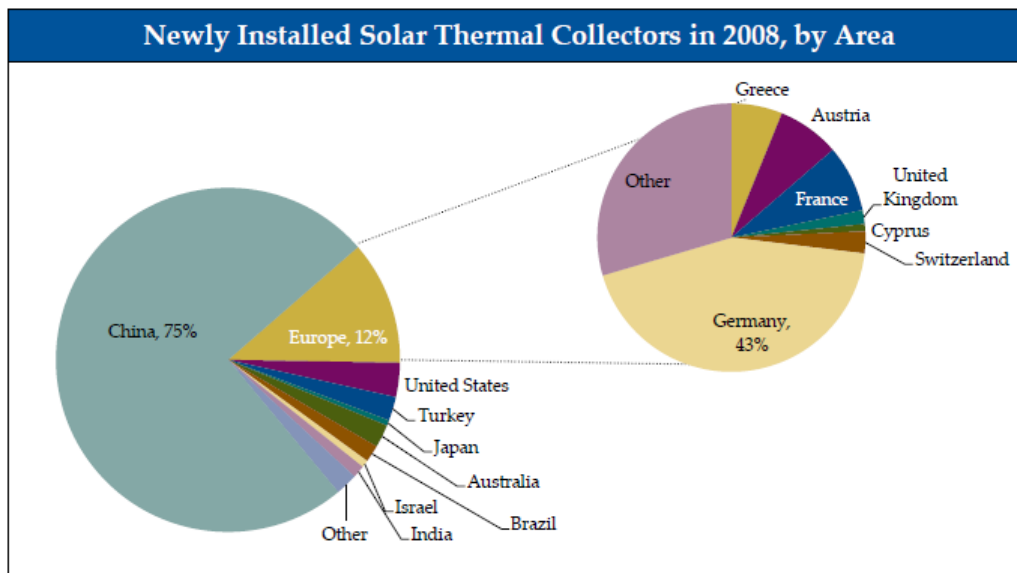

Navigant Consulting, Inc.,
used by permission

Source: International Energy Agency Solar Heating and Cooling Programme, *Solar Heat Worldwide – Market and Contributions to the Energy Supply 2008*, Edition 2010, May, 2010.

Figure 27. World market for solar thermal collector installations⁴

⁴ Graph provided by Navigant Consulting, Inc. Source: Weiss, Werner and Franz Mauthner. May 2010. [Solar Heat Worldwide: Markets and Contribution to the Energy Supply 2008](#). IEA-SHC Programme. Paris France.

Growth figures for the period 2000–2008 tell a similar story. Figure 28 shows that some of the most dynamic markets for glazed SWH collectors (flat-plate and evacuated tube) are in the Middle East, China, Australia/New Zealand, and Europe.

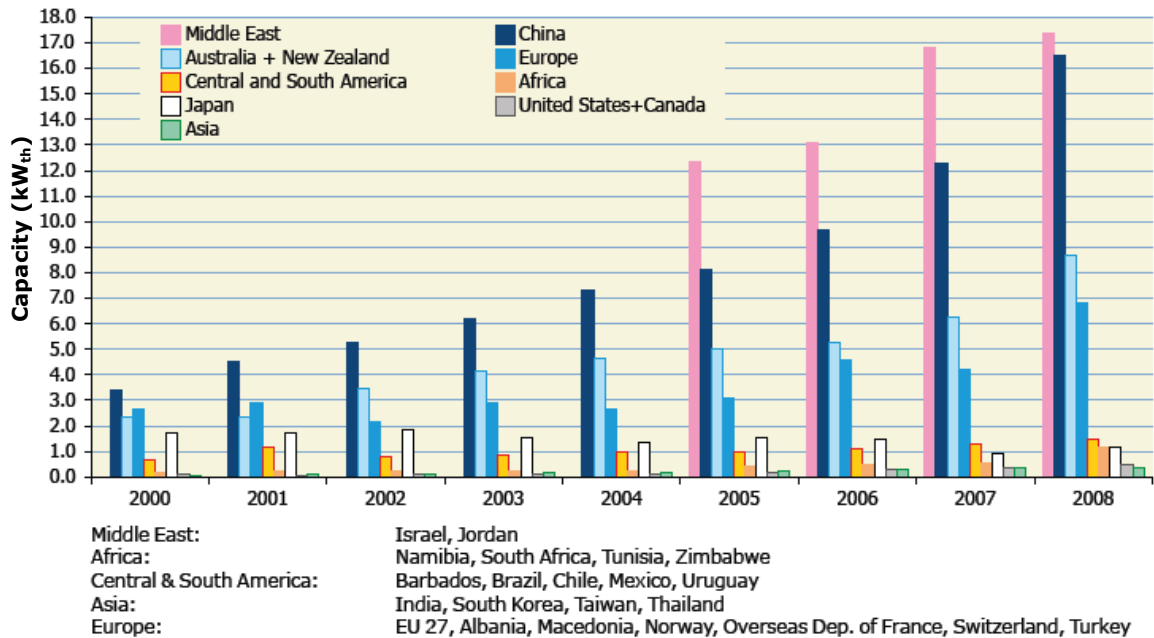

Weiss and Mauthner (2010),
used by permission

Figure 28. Glazed and evacuated tube collector capacity ($\text{kW}_{\text{th}}/1000$), 2000–2008

The primary driver of solar thermal growth in the Middle East, particularly Israel, has been the law that the Israeli legislature passed in 1980 requiring the installation of SWHs in all new homes (except tall buildings with insufficient roof area). As a result, Israel is now second in the world in the use of solar energy per capita (85% of the households today use solar thermal systems). (Cyprus is first with 90% solar thermal penetration.) Spain also introduced a national solar thermal obligation for new buildings in 2006 (ESTIF 2007).

Solar thermal growth in China has mostly been due to the local manufacturing of low-cost, unpressurized evacuated tube systems and the limited availability of electricity and natural gas for water heating in rural areas. There is also often no provision for SWH system freeze protection, which helps to lower overall system costs. The typical Chinese SWH system would not be suitable for the North American market.

Outside of regulation, some lessons learned from the significant growth of SWH technologies in Europe and Australia include:

- Long-term policy support of solar thermal incentives enables the industry to plan long-term and invest in market growth accordingly.
- Public education campaigns that raise consumer awareness and point out the benefits of solar thermal systems help create customer demand.

2.3.4 Opportunities and Market Growth Potential for Low-Cost Systems

This market analysis shows that solar technologies account for only a small portion of the U.S. water heating market. One way to increase the market quickly is to extend the SWH industry to include the major WH manufacturers. Figure 29 shows that in 2008, 96% of the residential WHs sold in the United States were produced by one of three manufacturers: A.O. Smith, Rheem Manufacturing, and Bradford White (DOE 2010b). Rheem also led the market for tankless units, selling more than half of all models (DOE 2010c).

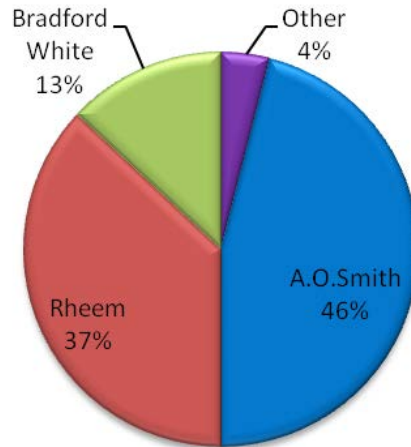
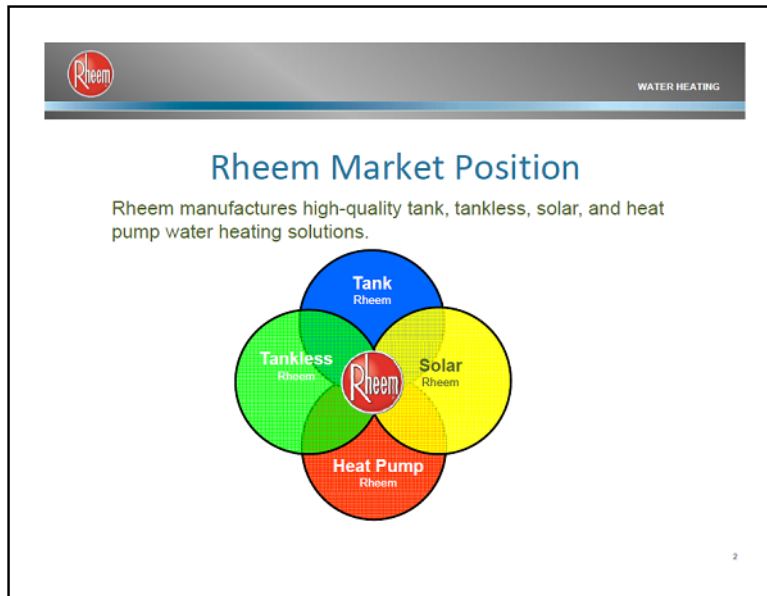

Figure 29. 2008 market shares for residential WHs

All of the three major water heater manufacturers include SWHs in their portfolios of water heating products. Figure 30 shows a slide Rheem presented at the ENERGY STAR Partners Meeting in 2010. Solar makes up one of four main areas in their WH portfolio. Low-cost SWH systems produced by a large manufacturer could significantly increase the U.S. SWH market.



Rheem, used by permission

Figure 30. WH portfolios for Rheem

The market growth potential for SWHs was estimated using a market penetration model based on NREL’s Solar Deployment Systems (SolarDS) – Water Heating (WH) modeling program (Denholm et al. 2009). This program determines the probability that a homeowner will install an SWH system. It takes into account the number of single-family homes that are available for SWH installations and assumes a maximum adoption rate of 75%. Using this information, the potential market growth of SWHs in the United States can be calculated.

The base fuel prices used for these scenarios are based on the Annual Energy Outlook (AEO) 2009 projections. Regional examples of these prices and a slightly higher price scenario are depicted graphically in Figure 31. Figure 31 illustrates the two natural gas price scenarios in three regions: the highest price region (New England), the lowest price region (Mountain), and a medium price region (Mid-Atlantic.) Here, the base price scenario is given by AEO 2009 (solid line), and the high energy price scenario is given by 1% growth from 2008 to 2030 (dashed line).

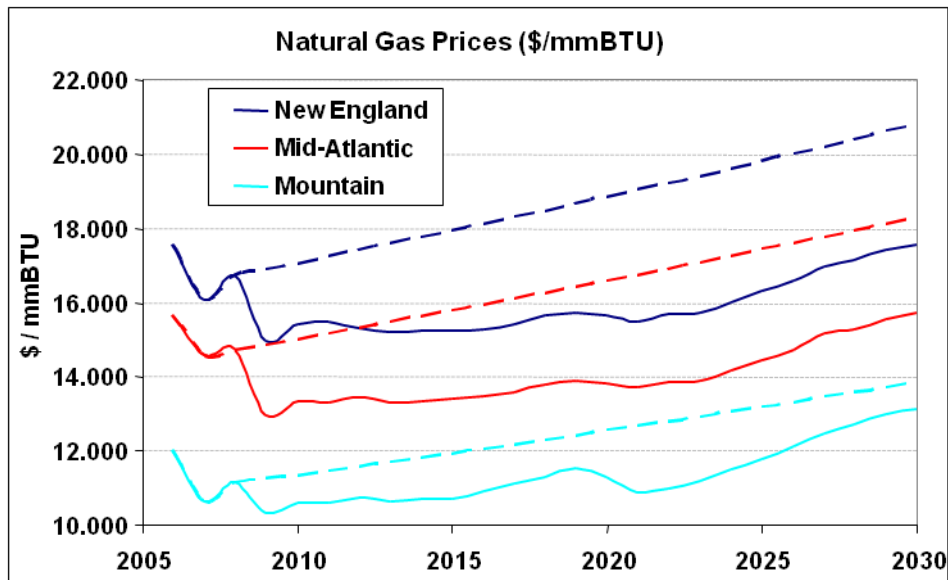

Figure 31. Average residential natural gas prices for AEO and high price cases

Four economic projections to 2032 are used to estimate the future market growth of SWH systems. Table 3 summarizes the four market penetration scenarios that were evaluated in the SolarDS-WH model from 2012 to 2032. The GPRA (Government Performance and Results Act) scenario uses target costs for DOE-supported low-cost SWH R&D from 2006. The “R&D” scenario assumes an accelerated version of the DOE/GPRA targets due to increased low-cost SWH R&D as well as enhanced market deployment.

Figure 32 illustrates the cumulative installed residential SWH systems under each scenario. The analysis includes the effect of the 30% federal investment tax credit ending December 31, 2016, but it does not include any state, local, or utility incentives. However, any such incentives are assumed to be included in the effective SWH system incremental costs.

Table 3. SolarDS-WH SWH Market Penetration Scenarios

Scenario	Fuel Price	2012 Incremental Cost	2032 Incremental Cost
1 – Business as Usual	AEO 2009 (flat/decreasing)	Baseline	~75% of baseline
2 – High Energy Price	Increases 1% per year	Baseline	~75% of baseline
3 – High Price/GPRA	Increases 1% per year	~65% of baseline	~45% of baseline
4 – High Price/R&D	Increases 1% per year	~65% of baseline	~35% of baseline

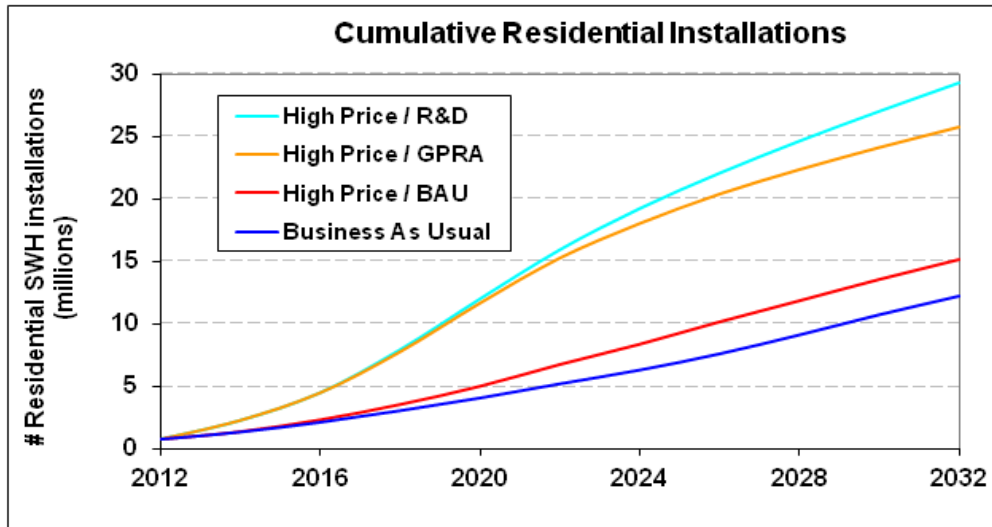
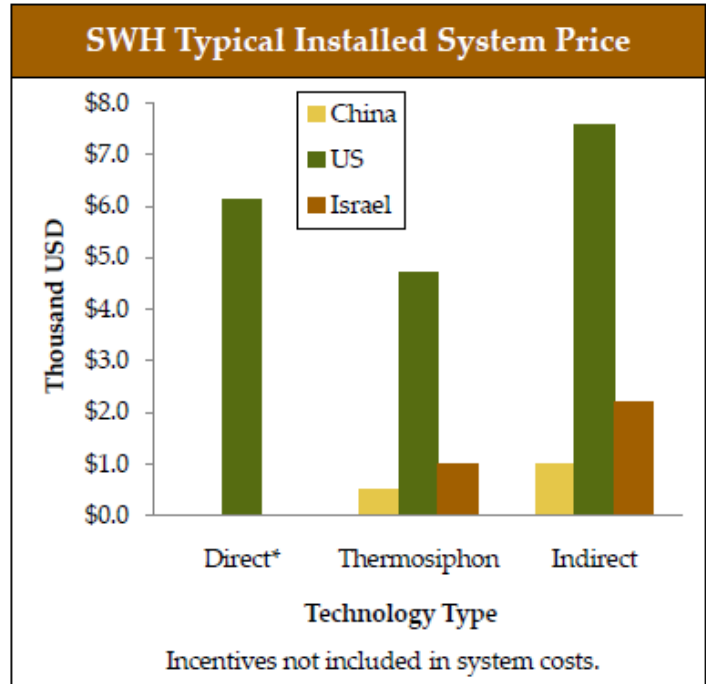

Figure 32. Residential SWH system installations for four market penetration scenarios

In a high energy price scenario using the accelerated low-cost SWH R&D cost targets, the number of residential SWH systems in the United States is estimated to reach more than 29 million in 2032. In contrast, a business as usual scenario with the same high energy prices would result in about 15 million residential SWH systems in 2032. Therefore, aggressive and sustained R&D for low-cost SWHs is estimated to almost double the number of residential SWH systems in 2032 compared to that scenario. The number of installations for the business-as-usual case is likely optimistic based on assumptions made in this study, but it is still valid to conclude that R&D will result in a 50% increase in the number of SWH installations by 2032. Research shows that significant market penetration would enable the reduction of U.S. natural gas consumption by approximately 4% (Denholm 2007).

2.4 Low-Cost Solar Systems

As mentioned in Section 2.3.3, the largest growth in the solar thermal market can be seen in Israel and China. Figure 33 shows the installation costs for SWH systems in these two countries compared to the United States. This graph shows that the costs of SWH systems in the United States are significantly higher than in countries with large growth. It should also be noted that although thermosiphons are the most inexpensive systems, the installed price in the United States is still significantly higher than in other countries.



Navigant Consulting, Inc.,
used by permission

Figure 33. Installed SWH system costs⁵

*Direct systems are uncommon in China and Israel

Table 4 compares typical characteristics and costs of SWH systems in the United States, Israel, and China. Again, the low end of costs in China are for unpressurized and freeze-unprotected systems that are not suitable for the North American market.

The costs of the U.S. systems can be attributed to differences in system type, system size, quality and certification standards, differences in buildings leading to varying installation locations, and the volume of installations.

⁵ Graph provided by Navigant Consulting, Inc. Sources: Israel: Amcor, Pro, Tovtoda. China: Changzhou Erjin Solar Energy Equipment Co., Zhejiang Shentai Solar Energy Co., Changzhou He Jia Solar Energy Co., China Vervsolar Technology Co., Haining Oupairineng Solar Water Heater Co., Beijing Sunpu Solar, Linuo Ritter International (China-Germany JV), Tecco Group. U.S.: Butler Sun Solutions, A.O. Smith, Caleffi, Solahart, Solene/ Chromagen, Alternate Energy Technologies, Fafco, Silicon Solar, SunEarth, Inc., TCT Solar, Solar Water Heating Supply Chain Market Analysis for the City of Milwaukee, Navigant Consulting 2010. U.S. costs confirmed against California Solar Initiative CSI-Thermal Program reported costs and HECO: 2007, Ron Richmond.

Table 4. Summary of SWH Systems in the United States, Israel, and China⁶

Characteristics	United States	Israel	China
Typical Installed Cost (domestic, 2-4 people)	\$5,000-10,000	\$1,000-1,800	\$300-1,000
Most Common Technology	Indirect (with pump)	Thermosiphon (no pump)	Thermosiphon (no pump)
Tank Capacity	80 gal	~30 gal	30-50 gal
Collector Sizes	~50 sqft total	~20 sqft total	~20 sqft total
Backup System	Conventional electric/gas	Electric heating element	Electric heating element
Quality	Highest. SRCC certified	High. Some are SRCC certified	Low. Many not certified. Shorter system life.
Typical Installation	Collectors on pitched roof. Indoor tank. Complex design. Building not designed for SWH. Limited SWH experience. High labor costs.	Collectors and tank on flat roof. Simple system. Building designed for SWH. Experienced installers. Medium labor costs.	Collectors and tank on the roof (some flat, some pitched). Simple system. Experienced installers. Low labor costs.
Market Volume	30,000 installs/year	70,000 installs/year	6,000,000 installs/year

Table 5 lists the impacts of addressing the cost factors associated with the high costs of the SWH systems in the United States. The cost factors with the greatest impact are technology choice, design, building SWH preparation, and installation. Based on this information, the up-front cost of systems must be addressed by developing innovative low-cost systems and working with installers to improve their skill sets and knowledge. The impact of addressing technology choice and design on the installed cost of an SWH system will be discussed in more detail in Section 4. Building preparation is a target for new construction and would not result in large market penetration in the near future. It is therefore not emphasized in this roadmap. Installation costs are also an important part of overcoming market barriers and reducing the installed cost of systems. It is believed that developing less complex, lighter weight systems and supporting the standardization of systems and installation practices will greatly reduce these costs.

⁶ Table provided by Navigant Consulting, Inc. Sources: Israel: Amcor, Pro, Tovtoda. China: Changzhou Erjin Solar Energy Equipment Co., Zhejiang Shentai Solar Energy Co., Changzhou He Jia Solar Energy Co., China Verysolar Technology Co., Haining Oupairineng Solar Water Heater Co., Beijing Sunpu Solar, Linuo Ritter International (China-Germany JV), Tecco Group. U.S.: Butler Sun Solutions, A.O. Smith, Caleffi, Solahart, Solene/ Chromagen, Alternate Energy Technologies, Fafco, Silicon Solar, SunEarth, Inc., TCT Solar. U.S. costs confirmed against California Solar Initiative. All: IEA Solar Heat Worldwide 2010. CSI-Thermal Program reported costs and HECO: 2007, Ron Richmond.

Table 5. Impact of Reducing Cost Factors for U.S. SWH Systems⁷

Cost Factor	Impact	Explanation for Higher U.S. Costs
Technology Choice	High	The indirect system, which is the most common U.S. system type, is more expensive than the thermosiphon system, which is the dominant configuration in China and Israel.
Design	High	More complex systems with higher quality materials and additional features drive higher material and installation costs.
Building SWH Preparation	High	Buildings in Israel are designed to be SWH-ready, significantly reducing labor and material installation costs.
Installer Costs	High	Inexperience, higher overhead/marketing, less standardization, and less competition contribute to higher installation cost.
System Capacity	Medium	U.S. systems use double the collector area and storage tank capacity to meet U.S. hot water capacity expectations
Labor Rates	Medium/ Low	Higher labor rates increase installation costs, but they have a relatively small impact on total costs relative to Israel.
Quality	Medium/ Low	Chinese system quality is inferior but Israeli systems are certified to US and European standards.
Manufacturing Volume	Medium/ Low	Lower U.S. manufacturing volumes relative to both countries has a modest impact on total cost, as it impacts primarily collector costs, and Israeli market is not so large.
Pressure Requirements	Low	U.S. end-users expect hot water at a high and steady pressure, necessitating pressurized systems, but expectations are less stringent in China and Israel.
Incentives/Rebates	N/A	U.S. incentives are far more generous than those in China and Israel.

⁷ Ibid

3 Materials, Manufacturing, and Labor Resource Status

In general, SWH technologies do not require exotic or rare materials, as there are substitutes for many materials, and competing materials can serve similar applications. Manufacturing relies on equipment and techniques for handling glass, metal components, and polymers that are widespread in modern factories. In the United States, new SWH manufacturing could draw on experience in scale-up and automation gained by higher volume manufacturers in other countries. The SWH labor pool can draw on workers with skill and experience from other manufacturing, engineering, and construction fields. The following sections discuss these considerations in more detail.

3.1 Material Requirements

For all SWH applications, the primary components are collectors, storage, and balance of systems (BOS) components. Figure 34 shows the distribution of the SWH component market based on the U.S. market size estimates in 2009. Solar collectors and their mounting structures make up half of the estimated SWH component market value of \$400 million. BOS components—tanks, HXs, circulating pumps, sensors, gauges, valves, tubing, and insulation—make up 38% of the 2009 SWH component market value.

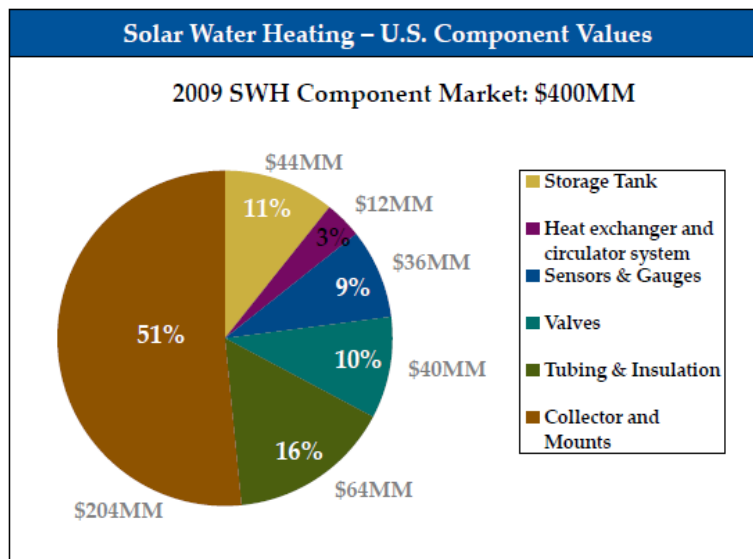

Navigant Consulting, Inc.,
used by permission

Figure 34. U.S. SWH component market values⁸

3.1.1 Collectors

Collectors—made mostly of copper, aluminum, and glass—are the most materials-intensive components of an SWH system. Their costs have risen (and fallen) dramatically in recent years. Copper, for example, has ranged from a low of \$0.76/lb in 2002 to more than \$4/lb in July 2008 and again in December 2010 (USGS 2009). Figure E-1 in Appendix E shows the Producer Price Index (PPI) of copper ore as a commodity between 1994 and 2011 (U.S. Bureau of Labor Statistics 2011). The increase and fluctuation in copper prices have led to more use of aluminum as collector absorbers (Meyers 2011), but

⁸ Navigant Consulting, Inc., *Solar Water Heating Supply Chain Market Analysis: Study for the City of Milwaukee*, September 2010.

aluminum also has been increasing in price. Figure E–2 shows the PPI of aluminum mill shapes as a commodity over the same period (U.S. Bureau of Labor Statistics 2011). Developing material substitutes and designing to minimize copper, aluminum, and glass use can reduce the impact of commodity price volatility and its effect on the capital costs of SWH systems.

3.1.2 Storage

Most SWH storage tanks are built with glass-lined steel or stainless steel. The technology is the same as that used for conventional pressurized water heating tanks, although commercial and industrial systems may require larger tanks than residential systems. In addition, some SHW tanks have integral HXs that are either wrapped around the outside of the tank or located inside the tank. The PPI of iron and steel and domestic WHs as commodities can be found in Appendix E (U.S. Bureau of Labor Statistics 2011). The costs of these commodities have also risen (and sometimes fallen) dramatically in recent years. Inside the tank, water is the most common storage medium, but advancements in phase-change materials could result in a shift away from water because these materials have the potential to store more heat in smaller vessels.

3.1.3 Balance of Systems

BOS for SWHs consists primarily of pumps, valves, piping, and control systems. Copper (for piping) and brass (for pipe fittings, valve bodies, and pump housings) are by far the most prevalent BOS materials. The PPIs of copper and copper-based alloy pipe and tube as a commodity between 2005 and 2011 can be found in Appendix E (U.S. Bureau of Labor Statistics 2011). The fluctuation in copper prices has led to more use of stainless steel and polymer pipe. The PPI of plastic pipe as a commodity over the same period can also be found in Appendix E (U.S. Bureau of Labor Statistics 2011). Large commercial/industrial systems often use steel or stainless steel pipe because the larger diameter pipes in those installations cost less.

3.2 Manufacturing Capabilities

In the United States, SWH manufacturing (except for solar pool heating) is far from optimal because markets have been vulnerable to fluctuations in policy and energy prices. Many SWH production lines still rely heavily on hand assembly of collectors instead of automation. Most U.S. manufacturing lines for SWH and solar pool heating are not at full production capacity, and increasing the utilization rate of these factories will help the industry realize economies of scale by spreading out fixed costs across greater production. Greater production volumes would also enable greater automation, further lowering manufacturing costs.

In 2010, U.S. manufacturers had the capacity to produce approximately 8 million ft² of SWH collectors. Approximately 2.4 million ft² of collectors were produced, implying a SWH manufacturing capacity utilization of 30%. Solar pool heating manufacturing capacity utilization is estimated at approximately 40% (SEIA-GTM 2010). Figure 35 shows the locations of current glazed flat-plate collector and ICS system manufacturers in North America as well as their reported 2009 production. However, one of the top five U.S. manufacturers in this category (Heliodyne in California) is not shown on the 2010 map, as the map shows only companies that responded to a written survey.



Epp (2010), used by permission

Figure 35. 2010 North American map of flat-plate collector manufacturers

In contrast to the United States, European countries have stimulated collector manufacturing by promulgating long-term demand-side policies, resulting in more use of automation, greater influence over component suppliers, increased assembly and preparation of elements of the entire system on the factory floor (rather than relying on field adaptations), and a more diversified range of products. Despite the limited manufacturing taking place in the United States, the U.S. solar collector manufacturers offer the longest average warranty period—more than 10 years—of all collector manufacturers in the world. Figure 36 displays the results of a 2009 survey of 150 flat-plate and 50 evacuated tube collector manufacturers worldwide. The numbers in parentheses after the country name indicate the number of manufacturers who responded to the worldwide survey of 300 companies from 40 countries.

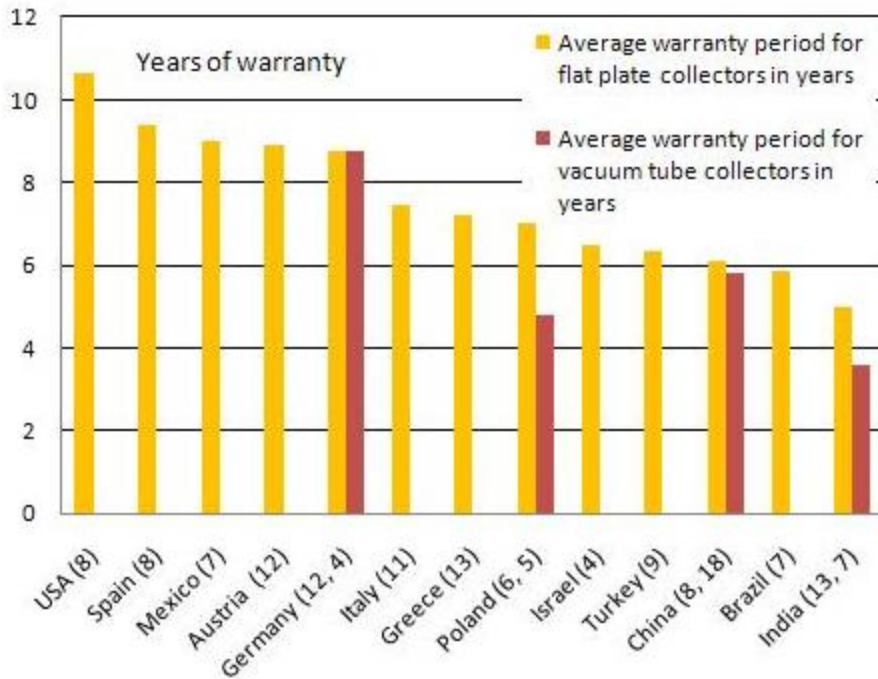

Epp (2010), used by permission

Figure 36. Average warranty period of flat-plate and evacuated tube collectors

Figure 37 shows the locations of current flat-plate collector manufacturers in Europe and worldwide as well as their reported 2009 production. Notably missing from this map (based on responses to a written survey) are collector manufacturers in Israel. Israeli manufacturers typically export glazed and unglazed collectors to the United States and the rest of the world in relatively large quantities. One Israeli manufacturer, Magen Eco-Energy, exports a significant number of unglazed polymer solar pool heating panels to the United States and has recently developed a glazed all-polymer water heating panel (Berner 2011).

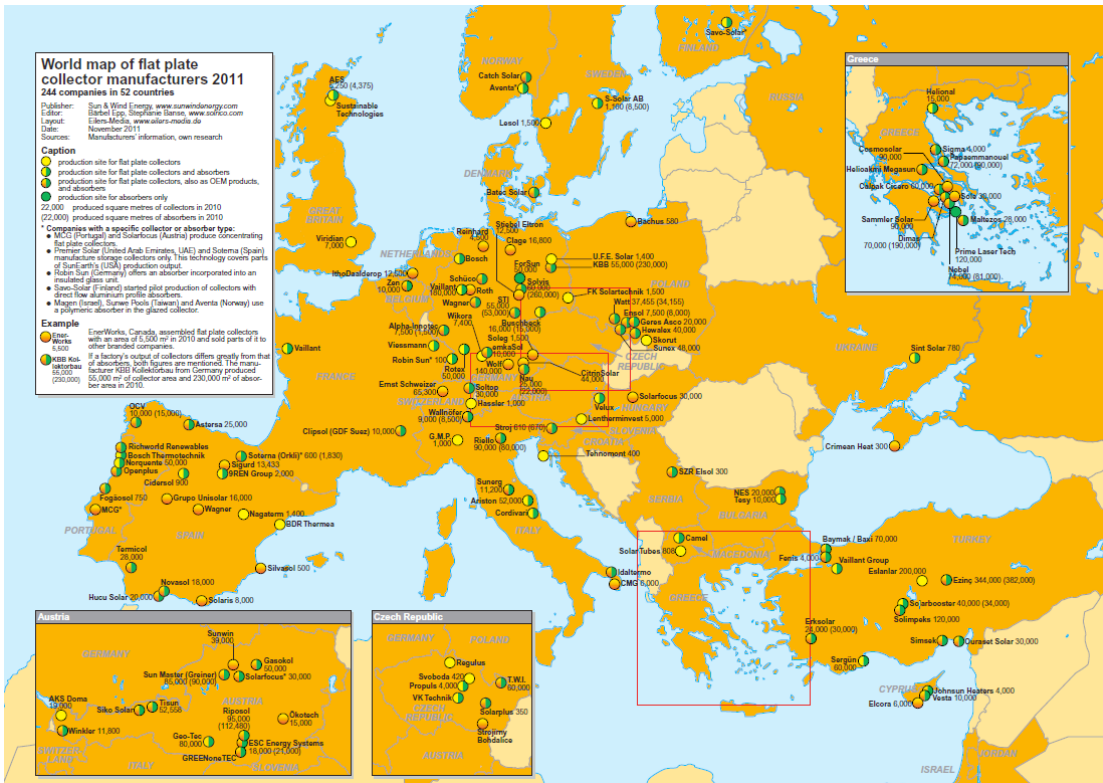
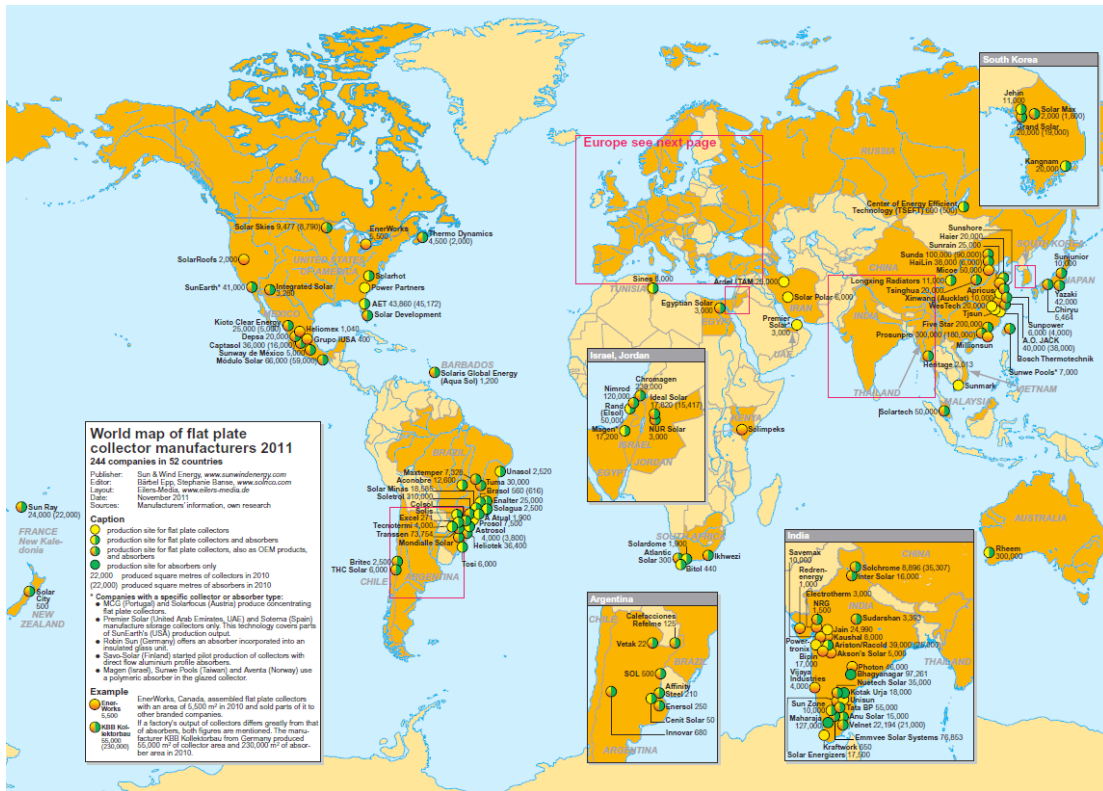

Figure 37. 2011 world map of flat-plate collector manufacturers

Epp (2011), used by permission

Production and use of evacuated tube collectors are growing worldwide; the nature of glass tube production favors high degrees of automation. In the late 1970s, evacuated tube solar collectors were first developed by Corning Glass in upstate New York using its experience in borosilicate (Pyrex) glass manufacturing. Corning's evacuated tube design was manufactured and marketed in the United States by Owens-Illinois and General Electric until the mid-1980s, when oil prices fell, federal incentives ended, and the U.S. solar thermal market collapsed. Both Owens-Illinois and GE stopped making evacuated tube collectors in 1985 and left the solar thermal industry.

Corning's evacuated tube tooling was supposedly transferred to a subsidiary in South Korea, where it languished until the 1990s. It was eventually adopted by Chinese manufacturers, who dominate the world evacuated tube collector manufacturing arena today. Evacuated tube solar collectors are also manufactured in India and Europe. Figure 38 shows the locations of current evacuated tube collector manufacturers worldwide as well as their reported 2010 production. The five largest evacuated tube manufacturers in China produced more collector area than all the 167 flat-plate collector manufacturers listed on the world map in Figure 37 combined.

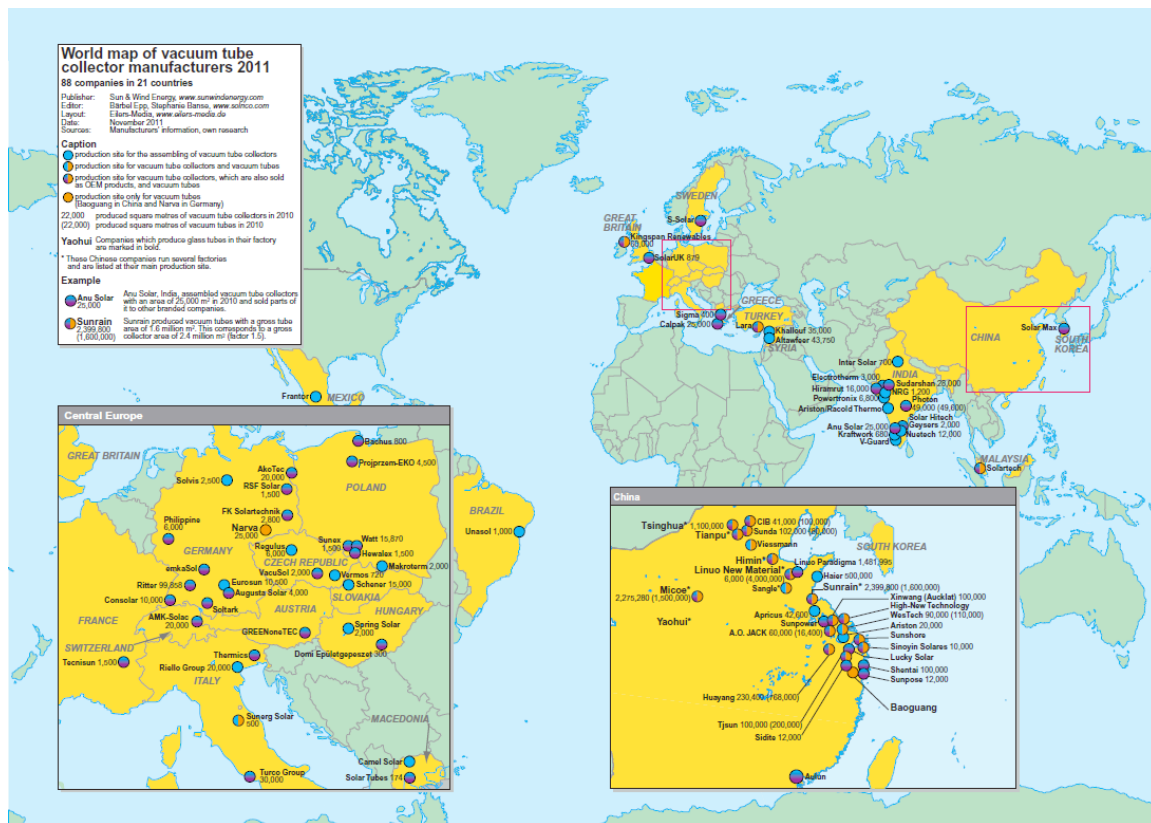

Figure 38. 2011 world map of evacuated tube collector manufacturers

3.3 Labor Resources

Labor is required for SWH manufacturing, design and installation, and O&M. The following sections discuss these areas.

Epp (2011), used by permission

3.3.1 Manufacturing

The types of labor required in SWH factory assembly vary with product type. Flat-plate collector manufacturing techniques typically involve metal cutting, drilling, brazing or welding, and adhesives and fasteners. Collector component assembly is followed by testing under pressurization and other quality tests. Evacuated tube collector manufacturing focuses more on the glass tubes and receiver assemblies, specifically on ensuring a quality vacuum in the glass tubes and on tube mounting connections in frame hardware. For flat-plate and evacuated tube collector manufacturers, greater integration of components in a factory setting before shipment to the installation site is a promising avenue for reducing costs. Examples include streamlined racking solutions, prebuilt pumping and HX modules, and other areas where field labor can be reduced or replaced by factory assembly.

3.3.2 Design and Installation

SWH design requirements mimic those of most mechanical systems, and the scale of the SWH installation often dictates the source of design services. Although residential systems are often site adapted by senior installers using preselected components, much equipment today comes prepackaged from manufacturers.

Residential and small commercial system installation requires expertise in roofing, plumbing, and basic electrical, skills that are not typically found together in the construction workforce. Because of their weight, SWHs may require more labor and equipment to install compared with conventional WHs. Also, some SWH systems must be assembled onsite, further raising installation labor costs compared with conventional WHs. Finding and training licensed SWH contractors are challenges in the limited U.S. SWH market.

3.3.3 Operations and Maintenance

Although SWH system O&M is simple and relatively inexpensive, it may be one of the most important factors needed for a sustainable and growing SWH industry. Trained SWH technicians are the obvious choice for ongoing service, but the market dictates that many plumbers and mechanical contractors will also be required for the upkeep of SWH systems. Training and licensing are important. Many of the first modern solar systems installed in the 1970s and 1980s were often brought offline because untrained workers were called on for service, resulting in misdiagnosed problems that otherwise would have been easily repaired. There have also been examples of major systems remaining offline because a single sensor, pump, or valve malfunctioned. The limited scale of the current SWH market is a problem for O&M because there is a lower concentration of systems in any one location, which increases travel costs involved in service.

4 Technology Improvements and Research Needs

SWH is a mature technology, but the fact remains that SWHs are not cost effective against the current price of natural gas, as was previously identified as the target market for SWH technologies. R&D can lead to significant advances in materials, design, and manufacturability, which can contribute to lowering the cost of SWHs, improving their performance, and easing installation—both in new construction and in retrofit markets.

Current SWHs are significantly more expensive to purchase and install than conventional WHs—in some cases, up to 10 times more expensive in retrofit situations. Driving down this first (installed) cost is essential to improving the economics of SWHs, and in turn, their marketability.

As mentioned in Section 1.1.3, the low-cost SWH project has set the following cost, performance, and reliability targets:

- \$1,000–\$3,000 total installed SWH system cost in existing homes at large market scale
- Maintain conventional SWH systems' 35%–40% source energy savings over conventional natural gas WHs in cold climates
- 15–25 year product lifetime with high system and component reliability and performance.

To summarize, technology improvement efforts for SWHs should focus on maintaining the performance and reliability of current SWH systems and reducing total system installation costs. Recent analysis led to identification of technology improvement opportunities (TIOs) to overcome barriers related to cost, performance, O&M, and reliability. For SWH systems, Figure 39 shows the TIOs at two high levels, starting at Tier 1 and further divided in Tier 2.

The estimated impacts of the Tier-2 TIOs on the metrics of performance, cost, O&M, and reliability are also shown in Figure 39. The results show that many TIOs have a high impact on cost, which indicates that R&D should focus on the metrics shown in red first.

When considering the installed cost of a SWH system, it is important to understand the factors that determine cost. One sensitive factor is whether the system is for new construction or a retrofit. New construction can eliminate many installation obstacles and minimize marketing, permitting, and other indirect costs.

Another significant cost parameter is incentives, which can amount for more than half the system price and significantly distort economic analyses. Because the emphasis here is federal R&D funding, the rebate distortions create invalid comparisons across technologies, and all costs given here are based on no incentives. Volume of installation and competition for the local installation firm also affects the installed cost (Burch et al. 2000). Component costs decrease significantly with volume, up to 50%/unit from a single system to volume purchase.

		Metrics			
		Performance	Cost	O&M	Reliability
Technology Improvement Opportunities (TIOs)					
TIER 1	TIER 2				
Collector	Absorber	Red	Red		
	Glazing	Red	Red	Yellow	Yellow
	Enclosure		Red		Yellow
	Mounting				Yellow
	Manufacturing		Red		
Storage	Configuration	Yellow	Red	Red	Red
	Container		Red	Yellow	Yellow
	Insulation	Yellow	Red		
	Manufacturing		Red		
Balance of System	Heat Exchanger	Red	Red		
	Pump(s)	Red	Red	Red	Yellow
	Controls	Yellow	Red	Red	Yellow
	Piping / Valves		Red	Yellow	Yellow
Systems Engineering & Integration	System Manufacturing / Assembly		Red	Yellow	
	System Installation	Red	Red	Red	Red
	System Design	Yellow	Red	Red	Yellow
	System Operation	Red		Red	Yellow
Deployment Facilitation	Codes and Standards			Red	Yellow
	Training and Certification				Red
	Education and Outreach			Yellow	Yellow

Figure 39. SWH TIOs. Shading indicates degree of impact each TIO has on each metric: red (dark) is high; yellow (light) is medium; no shading is low.

The results from the San Diego Solar Water Heating Pilot Program from 2007 to 2010 show the various categories that make up the installed cost of an SWH system (Itron 2011). Figure 40 shows the distribution of total SWH system costs for single-family homes. The systems analyzed were all residential retrofit systems, and cost fractions will vary somewhat from new construction scenarios. Average costs normalized by solar collector area are shown in $\$/\text{ft}^2$ for each major system category—storage tanks, collectors, installation labor, permits, and other—for five types of SWH systems installed under the incentive program. (The “other” category includes the costs of BOS equipment such as pumps, HXs, piping, and collector mounts, as well as warranties and other miscellaneous costs.)

For the first three types of active SWH systems shown in Figure 40, storage tanks, collectors and BOS equipment actually make up less than half of the total SWH cost. For the two types of passive SWH systems, equipment costs are approximately half of the total SWH cost. For the more than 300 San Diego SWH systems in single-family homes, storage tank and collector equipment costs averaged 38% of the total SWH cost. For the 23 multifamily and commercial SWH systems in the San Diego program, storage tank and collector equipment costs averaged 48% of the total SWH cost. Therefore, it is necessary to address more than equipment costs to reduce total system installation costs.

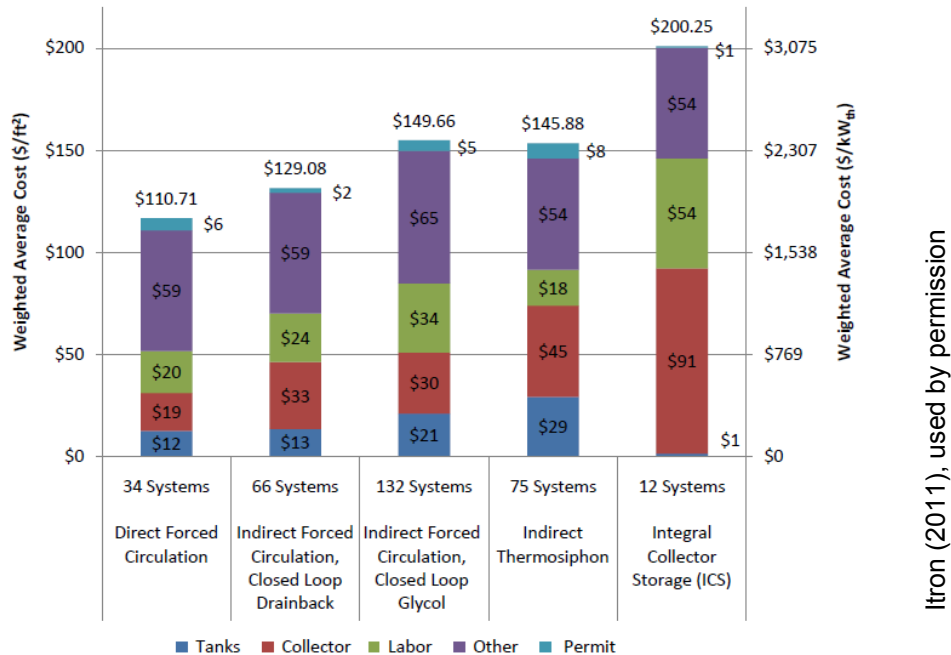

Figure 40. San Diego 2007–2010 single family SWH cost breakdown (\$/ft²)

The remainder of this section describes possible pathways for future research and product development activities to achieve the targets of the DOE low-cost SWH research activity. The options presented will address the top two cost factors listed in Table 5, technology choice, and design, and will prioritize the TIOs shown in Figure 39.

4.1 Pathway Option 1—Polymers

One pathway option for achieving a low-cost SWH is to replace conventional solar collector materials such as copper and glass with polymers. This reduces material and manufacturing costs and weight, which can reduce installation costs as well. In addition, polymer materials have not been subject to the skyrocketing prices of copper. Copper prices declined to an almost four-year low of \$1.25/lb in late 2008, but stood at more than \$4/lb in December 2010 (Kitco 2012). In contrast, the cost of commodity polymer materials has not risen as high as most metals. In most cases in 2010, the price of polymer materials remained below \$1/lb (Fumoso Industrial 2010).

Internationally, more than two thirds of solar collector manufacturers surveyed in November 2010 believed that plastics would become a key collector manufacturing material for the solar thermal industry over the next 10 years (Meyer 2011a). When asked which part of the collector was most likely to be substituted with a plastic part, 36% of the respondents said the frame, 25% the glass cover, 18% the absorber, and 11% the piping.

The polymer pathway option is shown in Figure 41. In this figure, the base case is a two-tank glycol system with a doubly pumped external HX. A schematic of the base system is shown in Figure 42, and the sizes and parameters used for this analysis are shown in Table 6. Figure 41 shows both the first (installed) cost of the system and the levelized cost of saved energy (LCOSE) for a rational sequence of TIOs applied to the base case system.

The LCOSE is defined as the net cost to install a SWH divided by its expected lifetime energy output.

In addition to the cost of the system, the installed cost includes direct materials and labor, overhead/profit, marketing, and O&M. Costs given in this section are for a new construction scenario with direct volume purchase, efficient installation, zero permitting cost, and low marketing. These assumptions provide costs at the low end of today’s range.

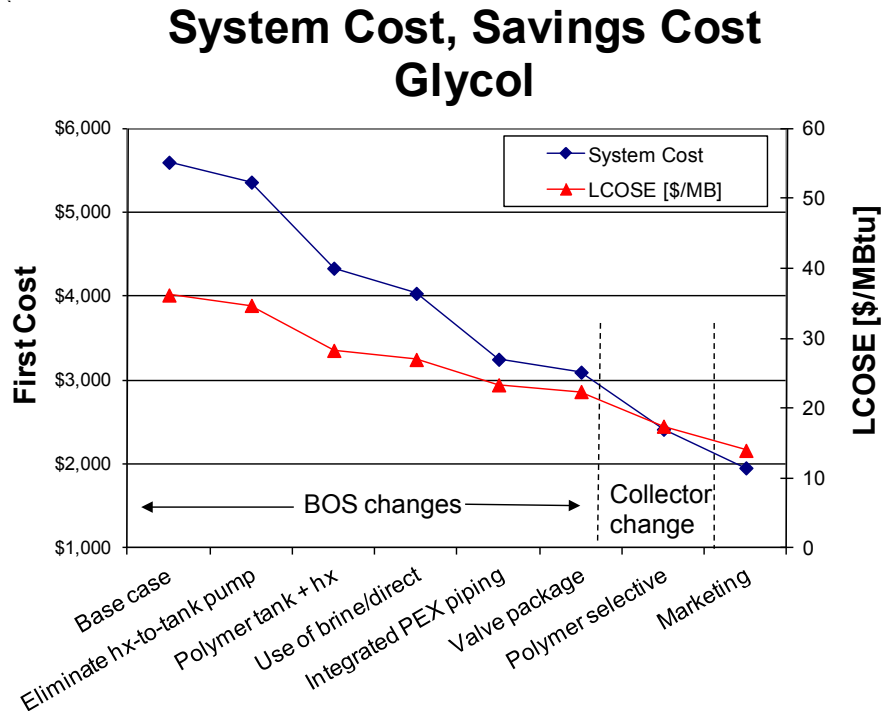

Figure 41. First cost and levelized cost of saved energy for a series of BOS and collector changes. Marketing cost is set at 20% of the system cost, resulting in an overall cost reduction once the BOS and collector changes are applied.⁹

The highest system cost is for the baseline system, shown at the far left of Figure 41. Reading left to right, the BOS variations are shown first, followed by the collector variations. The BOS changes are cumulative, and remain in for the collector substitution. In this example, cost reduction comes mainly from the use of polymer-based components, particularly collector, piping, and storage, with cost reduction percentages (savings values) of 12% (\$700), 14% (\$800), and 18% (\$1000), respectively. This analysis suggests that the program should first fund research to develop low-cost versions of collectors, tanks, polymer HXs, and polymer piping, as they have the largest impacts on system cost.

⁹ This figure is adapted to 2012 prices from data/figures in Burch, J., Hillman, T., Salasovich, J., *Cold-Climate Solar Domestic Water Heating Systems: Cost/Benefit Analysis and Opportunities for Cost Reduction*, Provided to DOE September 2004, available from kate.hudon@nrel.gov.

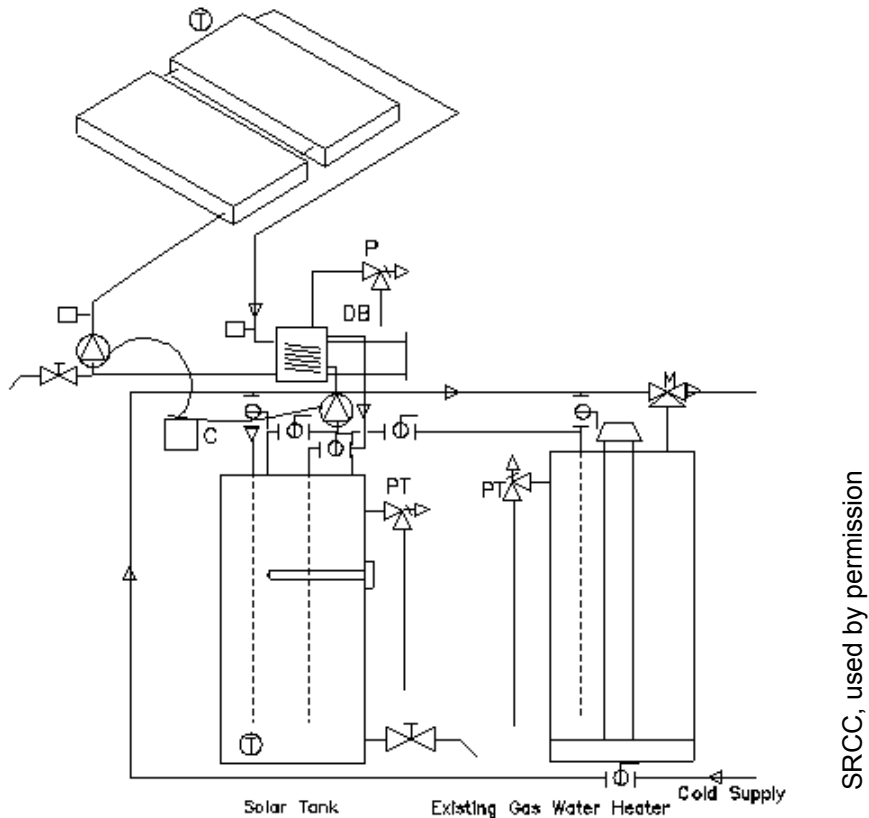

Figure 42. Schematic for SRCC TRNSYS model of a “typical” SWH system with a gas auxiliary WH (OG-300 System Reference: 2010016B)

Table 6. Base Case System Parameters

Collector (metal-glass selective)	
Area	3.72 m ² (40 ft ²)
Slope	33.7°
Solar tank (pressurized)	
Volume	0.227 m ³ (60 gal)
U-value	0.556 W/m ² -°C
Auxiliary tank (pressurized)	
Volume	0.15 m ³ (40 gal)
U-value	0.981 W/m ² -°C
Set point temperature	51.7°C (125°F)
Environmental temperature	20°C (68°F)
Piping (hard copper)	
Length (sup. + ret.)	15.24 m (50 ft)
U-value	2.27 W/m ² -°C

The cost reductions given here include the total hardware, installation, and O&M cost reductions (Burch et al. 2000). A cost model was used to determine the cost associated

with each assumed change (Burch et al. 2004). The marketing cost is set to 20% of the system cost, so it also reduces, and is shown as a cost reduction. This analysis was adjusted to represent current cost numbers (for 2012), as the initial analysis was performed in 2004 (Burch et al. 2004). To do this, the first cost data were multiplied by a factor of 1.8 to roughly normalize costs to system costs today (primarily driven by increases in the cost of copper and other materials since 2004). The LCOSE was computed as follows, using the annual efficiency method to estimate the saved energy (Blair et al. 2008):

$$\text{LCOSE} = (\text{Cost})/(\text{Discounted Saved Energy}) = (\text{FC}\$ + \text{PV}(\text{O\&M}))/[365H_{\text{day}}A_{\text{coll}}\eta_{\text{ann}}\text{PWF}(T_{\text{life}}, r_{\text{real}})]$$

where

FC\$	=	first cost, hardware plus install plus marketing costs,
PV(O&M)	=	present value of all O&M costs (Burch et al. 2000),
H _{day}	=	daily incidence onto the collector [kWh/m ² -day],
A _{coll}	=	collector area [m ²],
η _{ann}	=	the annual efficiency, defined as Q _{saved} /Q _{incident} , and
PWF(T _{life} ; r _{real})	=	the present worth factor, depending on the system lifetime T _{life} and the real discount rate (assumed at 3%).

This analysis shows that component substitution (replacing more expensive metal/glass components with less expensive polymeric-based components) can drive cost down by more than 50%, to the \$2,000 level, without significantly changing the system design. However, the figure also indicates that simple component substitution in a conventional glycol system will not reduce SWH costs to the \$1,000 level, and that the system needs to be redesigned to achieve further cost reductions. Other costs will also be incurred for retrofits that were minimized in the new construction scenario considered here, pushing costs up roughly another \$1,000 for retrofits. As will be discussed in the next pathway section, thermosiphons currently represent the best system type to attain prerebate first costs in the neighborhood of \$1,000 for retrofits.

The components presented in the above example and the assumed cost savings associated with those components are shown in Table 7. Figures 43 through 45 show examples of tank, HX, and collector components, transformed to low-cost components through the use of polymers. These technologies will be discussed in more detail in the following sections.

Table 7. Cost Reduction Measures and Associated Savings

Cost Reduction Measure	Savings ¹	% Savings ²	System Cost ³
Base case ⁴	–	–	\$5,600
Eliminate HX-to-tank pump ⁵	237	4.2%	\$5,363
Polymer tank + HX ⁶	1,026	18.3%	\$4,337
Use of brine/direct ⁷	300	5.4%	\$4,037
Integrated cross-linked polyethylene piping ⁸	785	14.0%	\$3,252
Valve package ⁹	154	2.7%	\$3,098
Polymer selective ¹⁰	680	12.1%	\$2,418
Marketing ¹¹	460	8.2%	\$1,958

¹ Cost savings from applying the TIO/measure

² Percent savings of the TIO relative to the base case cost

³ System cost after applying the measure

⁴ The base case is 40ft², selective collector, two-tank glycol system

⁵ Replace the pump between HX and tank with a natural convection loop between HX and tank

⁶ Replace pressurized tank with unpressurized membrane tank and polymer HX

⁷ Use non-freezing brine in storage and collector loop, eliminating glycol and the collector side HX

⁸ Use cross-lined polyethylene piping in the solar loop, replacing soldered hard copper

⁹ Integrate valving at tank (bypass, solar only, pressure relief, check valve, loop fill valves,...) with an integrated, factory-assembled package.

¹⁰ Replace selective metal-glass collector with low-cost selective polymer collector.

¹¹ Reduction in marketing cost, at 20% of system cost, due to the above system cost reductions.

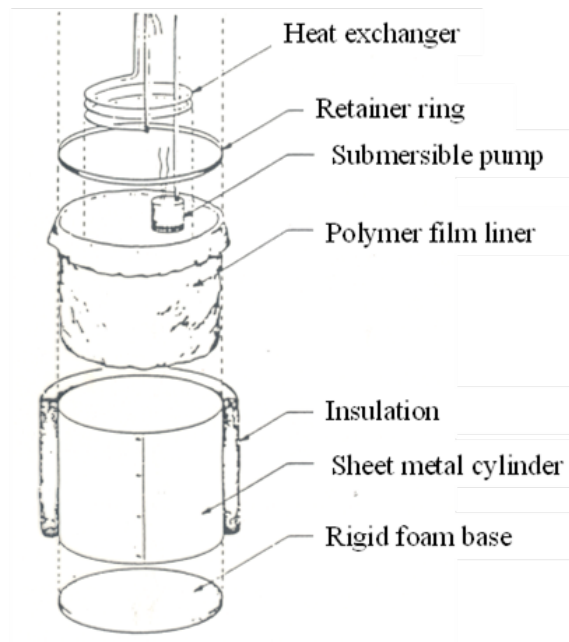

Wilhelm and Ripel (1985)

Figure 43. Schematic of low-cost polymer film membrane tank with immersed load-side HX and solar-loop pump



Rhodes (2004)

Figure 44. Prototype low-cost polymer HX. Tubes are 1/8 in. (3 mm) diameter. Tube production, tube weaving, and tube-to-header welding are automated processes, contributing to a low-cost projection.

Polymer Collector

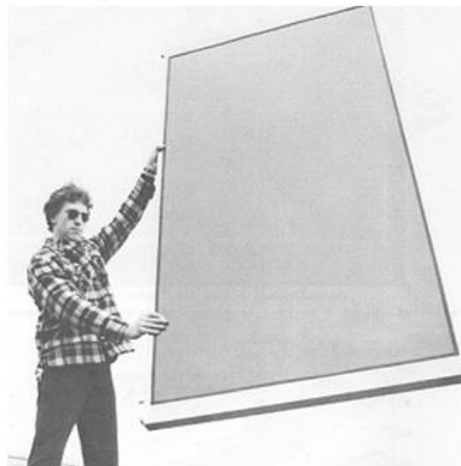

Wilhelm (1985)

Figure 45. Prototype polymer collector, made primarily with fluorocarbon films seam-welded to form the absorber, a stretched film glazing, and an aluminum frame

Development of the components hypothesized here would require relatively low R&D investment, as much of the work has already been done. The polymer collector can be an adaptation of today's low-cost pool collectors made from commodity polymers (polypropylene [PP] or polyethylene [PE]); the major R&D uncertainty is with the added glazing. Unglazed and glazed pool collectors are currently available. Research is needed to reduce the cost of the glazing. Either rigid glazings or polymer films can be used, the latter has potential for lowest cost. Previous work focused on rigid glazing materials such as polycarbonate (PC) and acrylic, and R&D is still needed in the field of polymer film glazings.

Screening for candidate materials and selective coatings are needed.¹⁰ Accelerated testing for ultraviolet (UV) degradation is also important (as in the 1981 Brookhaven prototypes, shown in Figure 45). Prototype HXs constructed from low-cost commodity plastics have been made, under Solar Heating and Cooling program funding in 2004, and from the small technology firm Rhotech Solar in 2011. The cost of a copper HX (at about \$250) more than doubled the system cost for a low-cost polymer film thermosiphon system under development at Rhotech. Cross-linked polyethylene (PEX) piping is widely available and could be used in the solar loop in systems today. Its only drawback is that stagnation in today's systems subjects the solar loop piping to excessively high temperatures upon circulation recovery during full sun. The R&D of adequate system overheat protection is therefore needed before PEX can be a low-cost piping option.

Overheat protection is critical to ensure the safe use of commodity polymers in collectors, tanks, HXs, and piping, and should be a high R&D priority. The unglazed FAFCO collector will not overheat simply because it is unglazed. The other polymer-based SWH available today is the glazed collector made by UMA Solar, which is overheat protected by a venting mechanism using memory shape metals. It has not yet been independently tested to determine maximum temperatures under full sun (Roberts 2005). Research demonstrated the need to provide low-friction paths for a venting mechanism, to limit temperatures to about 110°C, as suitable for PP materials (Jorgensen 2005).

Other overheat protection mechanisms include transparent thermochromic materials and allowing storage to boil (limiting tank temperature to 100°C). Thermochromic materials reduce transmission upon reaching a critical temperature.¹¹ Boiling of storage (necessitating water makeup) is another acceptable method of overheat protection. Boiling at 100°C is too hot already for polyethylene materials such as PEX. As a result, it will be necessary to use a mixing valve to limit temperatures to the PEX to 82°C (current limit for ASTM-rated PEX).

The results of this analysis show that the largest percent reduction in installed cost comes from replacing conventional pressurized solar storage tanks and metal HXs with unpressurized polymer tanks with immersed polymer HXs. The next largest increment of savings would come from polymer piping, followed by a polymer collector. Considerable work has already been done in these three areas, so these components could be developed with relatively low-risk R&D. If the polymer pathway is followed, overheat protection must be a high priority for R&D.

The following sections address each TIO listed in Figure 39 that had a high impact on the installed cost of an SWH system.

4.1.1 Solar Collectors

For flat-plate collectors, performance improvements over the past several decades can be attributed to the use of low-iron, tempered glass for glazing, improved insulation, and durable selective coatings. An order of magnitude increase in production could probably

¹⁰ Under development in International Energy Agency Task 39, Slovenia National Institute for Chemistry

¹¹ Under development in International Energy Agency Task 39, and at the University of Minnesota

help bring down collector costs, as today, many collector production lines are running at less than half of full capacity. However, significant cost reduction requires replacing copper, glass, and aluminum with polymer or composite materials that reduce material costs as well as weight.

Compared to other approaches for lowering the cost of SWH systems, using polymers has the following advantages:

- Relative ease of manufacturing
- Ability to consolidate multiple parts
- Potentially lighter weight leading to ease of installation
- Use of flexible, bundled piping for the interconnection of system components.

More than 30 years experience in the polymer-based solar pool heating industry has shown that unglazed polymeric collectors can be successful. Solar pool collectors are inexpensive and have long lifetimes when properly protected with UV inhibitors (mainly carbon black, which doubles as darkening). Relatively expensive engineering polymers have already been used in evolving European products. Norway's Aventa Solar is marketing a polymer solar collector with an absorber made from polyphenylene sulfide produced by Chevron Phillips.¹² That approach could be successful, as use of high temperature-resistant polymers can resolve overheating issues. As yet, the argument for use of the costlier polymers (some costlier than copper) seems more tenuous than proceeding with low-cost materials for aggressive cost reduction. The recommended approach is premised on using low-cost commodity polymers that can reach aggressive cost goals but present high-temperature issues that must be resolved.

4.1.1.1 Absorbers

Polymeric materials have heat conductivities that are three orders of magnitude lower than copper, inhibiting their use in high-heat flux applications. However, in low-concentration solar collectors, low conductivity can be addressed by using fully wetted design or by conductivity enhancement. Fully wetted design eliminates fins, keeping only thin polymer walls between the solar absorption point and the heat transfer fluid. All current polymer solar pool heating products use fully wetted design. If fins are desired, the conductivity of the polymer material will need to be enhanced. With 4-in. fins, an effective conductivity of about 10 W/m-K yields nearly the same collector performance as copper fins (NREL 1997). This conductivity can be attained with available additives such as boron nitride.

The key problem with glazed polymeric collectors with absorbers made from commodity plastics is the need for overheat protection. The stagnation temperature for glazed nonselective collectors can reach 260°F on hot summer days, which can cause failure in commodity plastics. A passive approach to overheat protection of polymeric absorbers in glazed collectors is the use of thermotropic coatings to limit their temperature within safe limits. Available approaches today use the concept of small particles of material #2 imbedded in a clear matrix of material #1. The material #2's index of refraction matches

¹² <http://aventa.frigl.net/eng/Solar-Energy/AventaSolar-solar-collector>

the matrix material #1 well when it is in phase 1, and changes significantly in phase 2—induced at or above a transition temperature. The index mismatch causes scattering, which reduces transmission through the coating. Figure 46 shows the reduction in transmissivity of a clear coating, upon crossing the phase transition.



Figure 46. Thermotropic polyamide in clear and scattering states

4.1.1.2 Glazings

Low-cost glazings include rigid, self-supporting polymer sheets (usually with stiffening ribs) and flexible polymer films that must be used in tension. In previous low-cost SWH research, partners all gravitated toward rigid polymer sheets thermoformed to the collector absorbers, primarily because they are relatively easy to manufacture. Experience has shown that rigid polymer glazing can also last more than 20 years with proper UV protection. Similar work is needed to test and ensure adequate lifetime of flexible polymer film glazings properly protected from UV. Bulk and surface coatings need to be investigated and tested.

Lowest costs may stem from polymer films, if lifetime and reliability issues can be resolved. The performance of unprotected PE or PP films will diminish in the presence of UV rays. UV-protected greenhouse films of PE can last 10 years (Ruesch and Brunold 2008). Further work is needed to see how useful these could be if an additional UV coating were applied. Fluorocarbon films could also be useful. Tefzel seems to have adequate lifetime with regards to UV and toughness; however, it is relatively expensive in reasonable thickness of 1–2 mil, costing about \$1/ft².

Little information was available about lifetime of rigid thermoformed glazings at the elevated temperatures experienced with solar applications, so a testing program was established to determine their durability. Samples were tested at 1X (one sun) in an outdoor exposure rack, at approximately 6X in WeatherOmeter chambers, and at 50X in a UV accelerator. The 50X device uses outdoor UV concentrated by selective reflectors and allows for testing at two temperatures. The WeatherOmeter chamber has a 2X lamp that runs continuously, giving about 6X acceleration. Typically, a decrease in hemispherical transmittance is used to indicate structural changes that are precursors to material failure. Figure 47 shows the results for PC glazings coated with a UV-protection film. Samples

were tested at 60°C and at 20°C. The 60°C value is the maximum attainable glazing temperature, and represents 24/7 stagnation. The data show that these PC samples have a lifetime of at least 20 years; the 60°C samples show damage at 15–20 years equivalent dose. This kind of data is needed for coated polymer films.

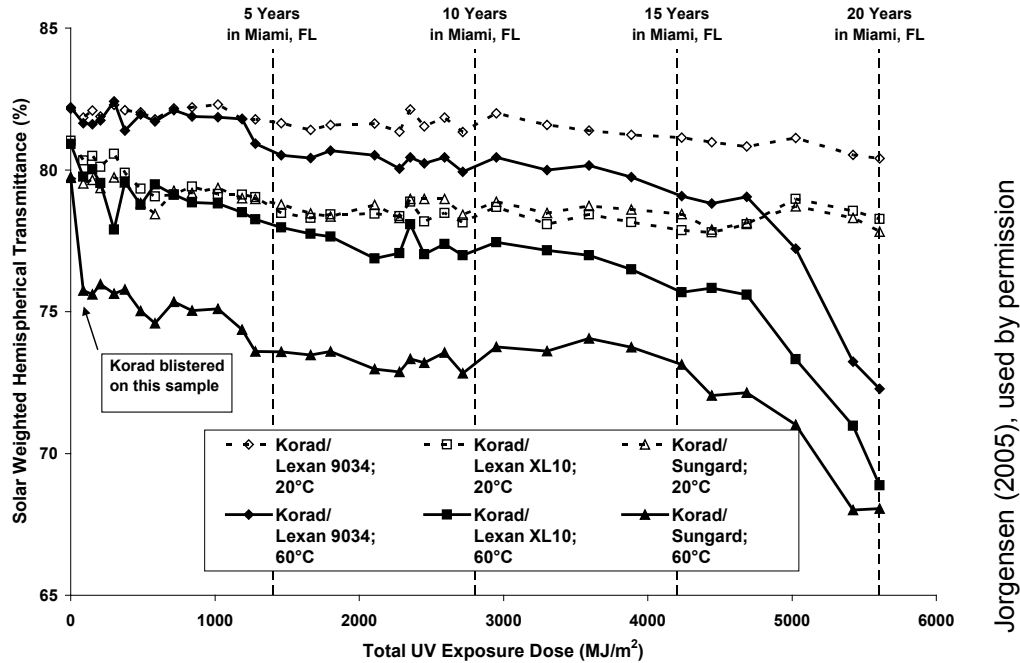

Jorgensen (2005), used by permission

Figure 47. Test results on 3 brands of clear PC with a UV-absorber top coating, at temperatures of 20°C (open symbols) and 60°C (solid symbols)

For commercial systems that must have proven high performance and longevity, the use of alternative materials in these systems may be delayed or even excluded. Producing large-format collectors (Figure 48)—which are larger in area and thus require fewer connections per unit of energy produced—could still reduce cost and improve performance for commercial systems. Figure 49 shows how the “per square foot” cost of a system decreases as flat-plate collector area increases (DOE 2011f). The two system data points on the far right are large format collectors.



SunEarth, used by permission

Figure 48. Large format collectors for Dallas Convention Center

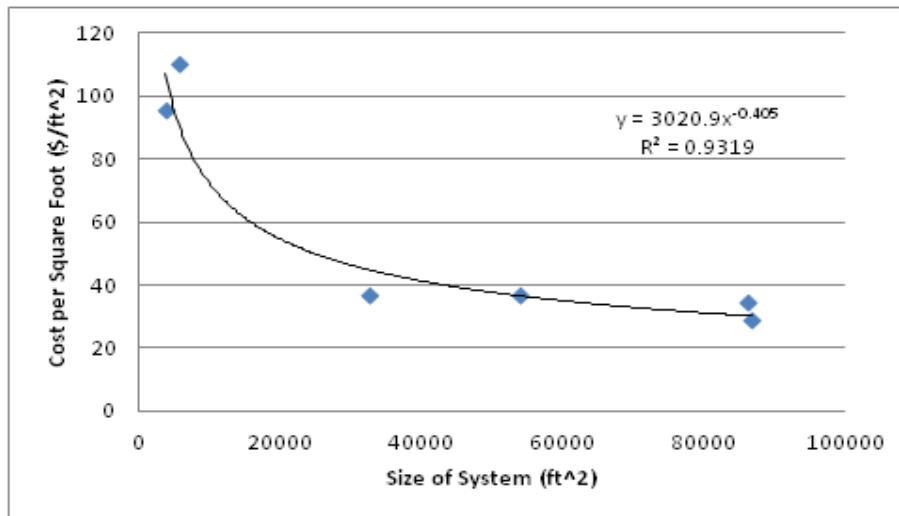

Figure 49. Flat-plate collector cost per area

4.1.2 Thermal Storage

For active systems with storage separate from the collector, storage is a major cost component. Historically, most active systems have used pressurized storage. As shown in Figure 41, using unpressurized storage could reduce costs, although a load-side HX with high effectiveness is then required. Unpressurized storage can be made from thin-wall polymer tanks (rotomolded or blow-molded) or from a membrane held in place by an external structure (e.g., cylindrical insulation plus metal or nylon sleeve, as shown in Figure 43). Enabling use of unpressurized storage will require developing and engineering design concepts, testing materials, building prototypes, and optimizing manufacturing.

There are numerous interesting approaches to lowering storage cost using unpressurized vessels. A number of companies have recently come out with lower cost tanks. Advantages of plastic vessels include low-cost, lightweight (lowered installation cost), and excellent corrosion resistance (longer lifetimes).

4.1.2.1 Membrane Tanks

Flexible membranes are very inexpensive, but require a retaining structure to be built. Films are subject to failure from puncture, but are otherwise long lasting. Tanks from flexible materials are common in large sizes, mainly for low cost, and are becoming available in smaller sizes that are appropriate for residential use. Figure 50 shows a commercially available membrane tank, with costs at about \$2–\$3/gal and lower (costs are size dependent).

A key issue with membrane tanks is that water vapor permeates the membrane. Vapor will diffuse from high-temperature storage into the insulation and structure if the vapor is not blocked. The vapor will condense, reducing insulation value and spurring mold growth. A barrier is essential for long life and maintenance of insulation properties. Possibilities include thick films (about 30 mils) and multilayered film with aluminum foil barriers.



American Solartechtechnics,
used by permission

Figure 50. Rectangular membrane storage tank

4.1.2.2 Rotomolded Rigid Tanks

Rotomolded products include small items such as gas cans to larger items such as garbage cans and livestock water tanks. Molds are inexpensive because pressures are low, and the machine is not expensive (about \$250,000, compared to millions for high-pressure molders and extruders). However, the process is slow and energy intensive, making the cost per unit relatively expensive, especially in larger sizes where multiple items cannot be done with one charge. Rotomolding added about \$75–\$150 per tank to the cost of the Harpiris SunCache polymer ICS system (Davis Energy Group 2008), depending on volume of production.

Rotomolded tanks can become a cost-effective replacement for conventional pressurized storage tanks. Cost of the tank in volumes of about 100 gal can be fairly inexpensive, less than \$1/gal. Cost will increase because of the required immersed HX (which holds the pressurized potable water) and the insulation. A recently developed product from Solar Tank Works is shown in Figure 51. Unit volume cost of the storage is expected to be about 60% of comparable pressurized solar tanks; the corrosion-resistant polymer material increased the warranty and lifetime.



Solar TankWorks, used by permission

Figure 51. Unpressurized rotomolded tanks with immersed stainless steel HXs

4.1.3 Balance of System and Controls

4.1.3.1 Low-Cost Heat Exchangers

Low-cost HXs are an enabling technology for SWH systems that use polymer collectors. Mild climate polymer-based SWH systems currently use stainless steel or copper HXs that are expensive, subverting the cost advances possible with polymer collectors. Developing low-cost polymer HXs for solar applications is a high priority for solar heating advancement.

For unpressurized storage, an immersed load-side HX or an immersed tank-in-tank is typically used to extract the heat in the tanks. The tank-in-tank approach is used infrequently in the United States, but is popular in Europe with larger combi-system storages. It was an initial goal at the start of the low-cost SWH research to develop low-cost immersed load-side HXs made from polymers. This task was started because of the interest of an industry partner, with an early prototype shown in Figure 45. Polybutylene (PB) and PP were investigated in the initial study, which included burst studies with PB and prototype HXs from PP. However, PB piping samples burst unexpectedly, perhaps because the extrusion wall thickness was nonuniform. Long curing time made the pipes difficult to extrude and weld. For PP samples, the welded units could not be maintained leak free with the welding techniques used. Work was halted when the industry partner abandoned the concept and went to metallic HXs.

4.1.3.2 Piping

Piping in today's SWH system is almost entirely copper, because of its excellent high temperature and pressure resistance. However, copper piping is costly and expensive to install, potentially adding up to \$1,000 to the SWH system cost. It would be far preferable to use low-cost, flexible polymer piping, which is easier to install and much less expensive. This type of piping allows one segment to be snaked between storage and tank, avoiding soldering or connecting smaller piping pieces and elbows together. At present, PEX piping is approved when the system temperatures cannot exceed manufacturer's stated limits (180°F).

Passive SWH systems typically contain pressurized potable water in rooftop piping. The U.S. map on the left side of Figure 52 shows the probability in a 20-year period of

damaging pipe freezes. Passive systems using copper pipes are limited to markets shown by the red dots (zero freeze probability). As a result, passive systems are currently excluded from almost all of the United States. Passive systems are potentially a good way to decrease costs, so it is important to have available freeze-tolerant piping that can be freeze-thaw cycled indefinitely.

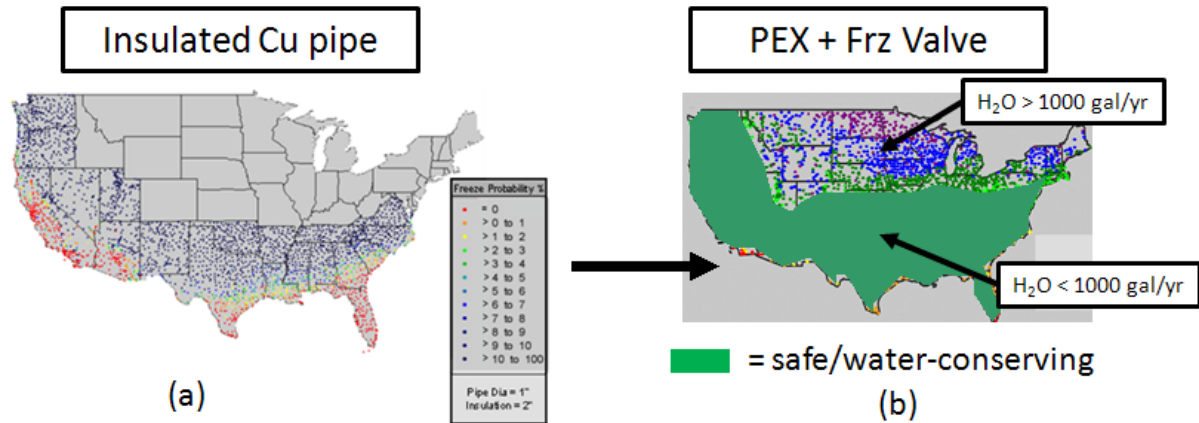

Figure 52. Probability of a pipe freeze over a 20-year system lifetime (left); water wasted by a freeze protection valve in a direct system (right)

A practical pipe freeze protection approach is provided by combining a sufficiently reliable primary freeze protection method with freeze-tolerant piping, enabling northward market extension. Freeze protection valves (FPVs) seem to be the least expensive option, but they do drain the water used to warm the piping, and carry away heat stored in the tank. The right side of Figure 52 indicates areas with FPV consumption of less than 1,000 gal/year. However, any primary means of freeze protection can fail usually in multiple ways, and there must be a fail-safe backup for the primary means of freeze protection.

Candidate continuous polymer piping that is freeze tolerant includes PEX and PB. Both materials are used for hot water piping. PB is used extensively in new construction in Europe, but is not available in the United States because early failures triggered a class action lawsuit. Several brands of PEX are freeze resistant, surviving more than 500 cycles of freeze-thaw without rupture (Burch et al. 2006a). PEX can serve as a fail-safe backup piping, if it can be shown to tolerate short-term high-temperature exposures at 100°C or so.

4.1.4 System Engineering and Integration

Another R&D pathway for lowering the cost of SWH systems is with HPWHs. All SWH systems require some form of backup WH, so a solar-assisted HPWH has potentially high energy savings if total system cost can be reduced. One way to reduce costs on the solar side is to eliminate the solar storage, feeding the heat directly to the evaporator. Furthermore, for electric storage WHs larger than 55 gal, HPWHs will be required by law in 2015 (DOE 1998). Therefore, SWH systems with a large backup electric storage tank will need to be combined with a heat pump instead after 2015.

Burch et al. (2006a)

4.2 Pathway Option 2—Cold Climate Thermosiphon

This analysis indicates that simple component substitution in an active glycol system can reduce costs by around 50%, but also indicates that the process will not likely attain an installed cost of \$1,000 per system. The same conclusion resulted for a similar analysis with drainback systems, the other U.S. cold-climate system type (Burch et al. 2004). In general, the active system type, with pumps, controllers, and associated wiring and power supply, is too complex to achieve an installed cost of \$1,000. To reach that goal, a simpler system type, the cold-climate thermosiphon, needs to be developed.

Figure 53 shows side-by-side schematics of a glycol and a thermosiphon system. The thermosiphon system is simpler, eliminating the controller, pumps, sensors, and associated wiring. The thermosiphon transfers heat to the storage by a natural convection loop, as indicated in Figure 53c. Heat is transferred to the auxiliary tank by virtue of the draw flowing through the thermosiphon tank and, if present, HX. The life cycle cost of the circulation system in a glycol system is about \$500, including the hardware, installation, and O&M costs (DOE 1998). Furthermore, the circulation subsystem is responsible for more than 70% of the serious problems, as seen in a study of 10-year-old SWHs (Walker and Roper 1991).

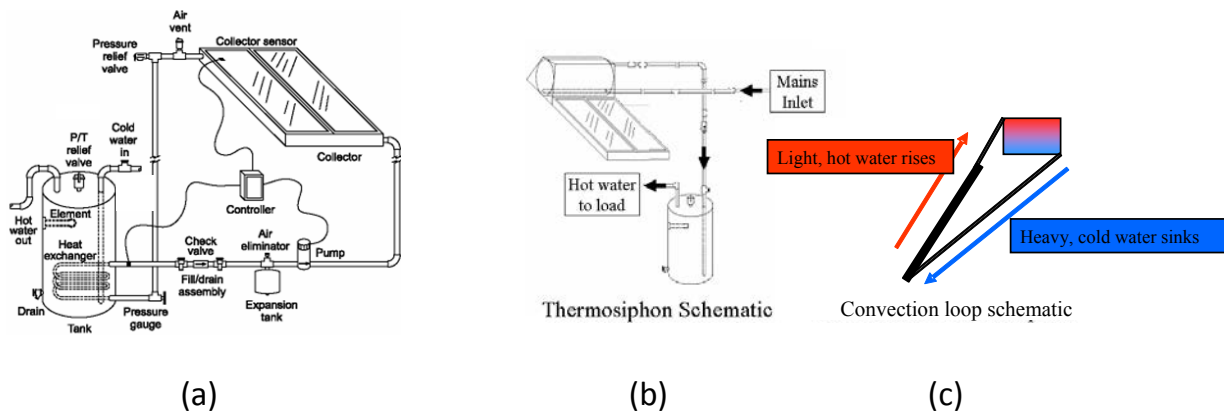

Figure 53. SWH schematics: (a): 1-tank glycol system, with solar tank having immersed HX; (b) non-separable thermosiphon; and (c) natural convection loop schematic

Changing from an active glycol or drainback system to a passive cold-climate thermosiphon system significantly reduces costs and improves reliability. Advantages and disadvantages of thermosiphons are given in Table 8.

Figure 54 illustrates the component substitution path for a conventional warm climate thermosiphon system, using mostly the same substitutions as in the glycol example. As in the glycol case, the cost data were developed in detail, and those costs were multiplied by 2.02 here to normalize for increased material and other costs today. As before, a new construction context is assumed. The base case is shown at the far left, with BOS substitutions first, followed by use of a polymer collector. With the market cost reduction, component substitution in a cold climate thermosiphon can attain an installed cost of \$1,000 for new construction. However, this system will not attain the \$1,000 goal for retrofits. Additional costs for retrofits include significantly higher costs for permitting,

marketing, distribution, and installation compared to new construction. These costs are highly variable for retrofits, and can add from a few hundred to a few thousand dollars, depending on the situation.

Table 8: Advantages and Disadvantages of Thermosiphon Versus Active Systems

Advantages	Disadvantages
No circulation subsystem ¹ ⇒ lower cost, and higher reliability	Potable water to roof ⇒ pipe freeze risk, potential high damages ²
Solar storage on roof/attic ⇒ no inside space taken by the SWH tank	Solar tank on roof ⇒ potential roof reinforcement required ³
No parasitic power ⇒ higher performance, and no electric utility load during peak hours	Tank visible on roof ⇒ decreased aesthetics with unsightly bulbous tank ⁴
	Collector freeze risk if not freeze protected ⁵

- 1 Includes pump(s), sensors, wiring, controller, and power supply
- 2 Pipe freeze risk can be eliminated with primary protection (circulating heat via natural convection) plus secondary (PEX pipe) freeze protection
- 3 Need for reinforcement ameliorated by placing tank at peak of roof
- 4 Tank aesthetic issue can be eliminated by placing the tank inside the attic at peak of roof, if tank is lightweight.
- 5 Collector can be freeze protected with indirect glycol solar loop, or direct brine loop with brine in storage. Requires all-polymer construction.

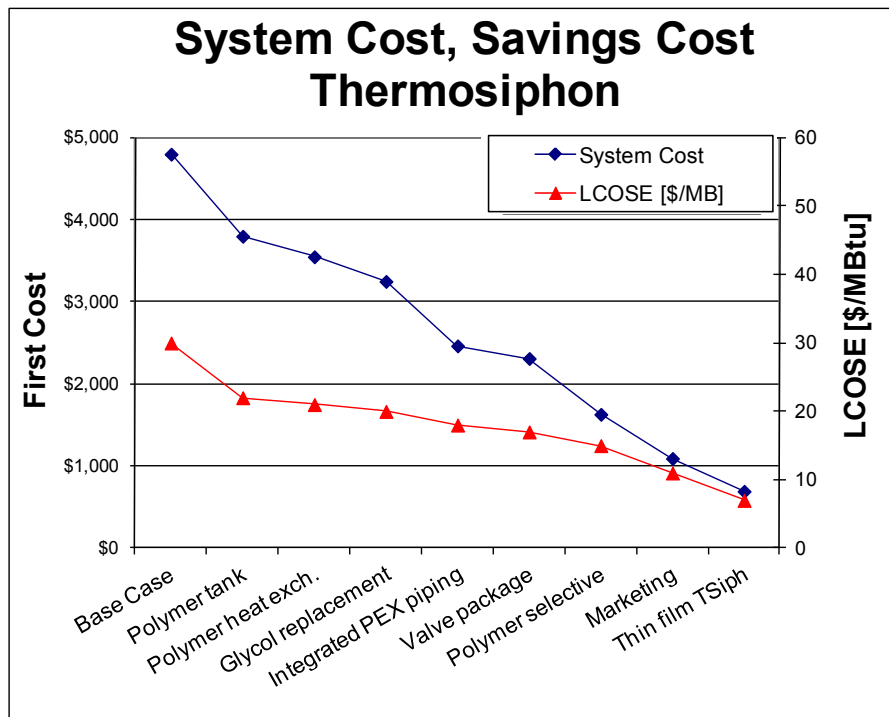

Burch et al. (2004)

Figure 54. Component substitution path for a thermosiphon system in a new construction scenario. BOS measures are followed by collector substitution and market cost reduction, indicating about \$1,000 cost. The last point on the right is for the polymer film thermosiphon described below.

4.2.1 Polymer Film Thermosiphon

The cold-climate thermosiphon can be simplified even further by integrating collector and tank in a single component made from seam-welded polymer film, as shown in Figure 55. Unglazed and glazed models are possible. The hardware freight on board cost is less than \$200, assuming the polymer HX (Rhodes 2004). With a copper HX, the hardware cost doubles, indicating the importance of the polymer HX for low-cost systems. Seams can be welded with high-speed lines, if collector volume is sufficiently high.

Materials testing in accelerated chambers is needed for resolving key durability issues of polymer films in absorbers, potential glazings, and storage. Diffusion of UV absorbents in polymer film should also be a R&D priority.

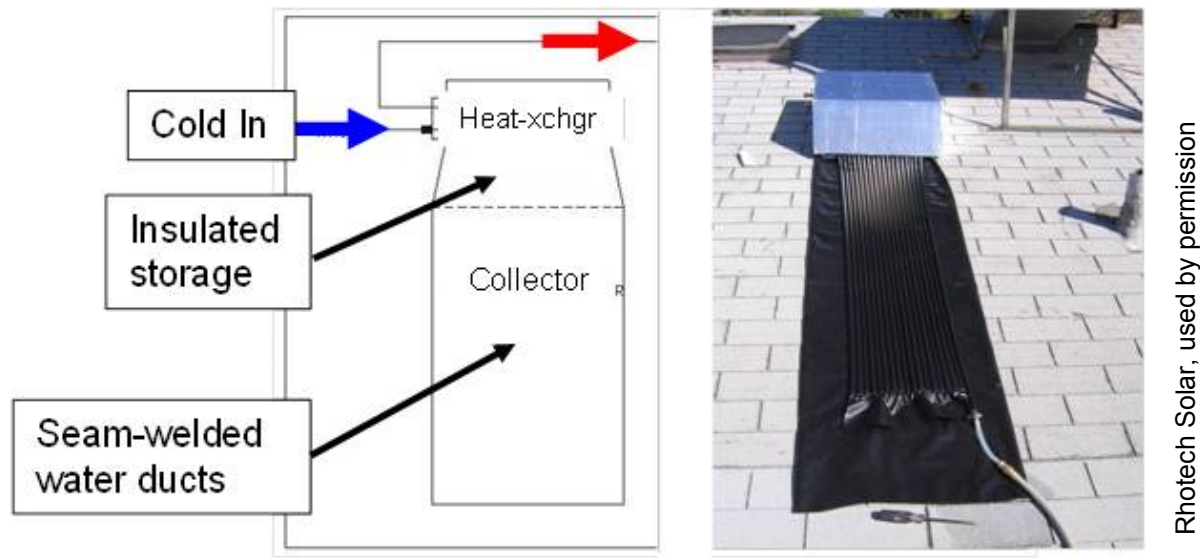
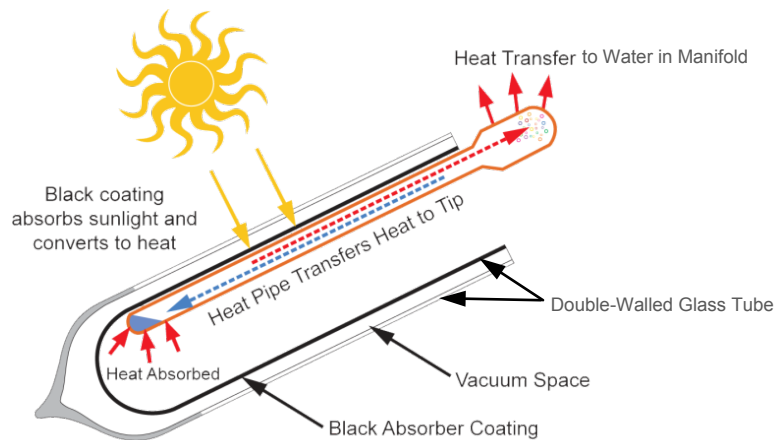

Figure 55. Polymer film thermosiphon collector/storage concept (left) and first 24 ft² unglazed prototype to test (right)

4.2.2 Evacuated Tube Thermosiphon

Evacuated tube collectors used in the United States are generally used in active systems and have been traditionally associated with higher costs along with higher unit area performance. There are two general types of evacuated tubes: single-wall tubes that necessitate metallic inserts (heat pipe or U-tube) to extract the heat and require troublesome metal-to-glass seals; and double-wall or “Sydney style” tubes with no glass-metal seals and potential for natural convection heat transfer with fluid-filled interior (as in the low-cost Chinese systems). A double-wall glass tube can also be combined with a heat pipe as shown in a schematic of an Apricus evacuated tube solar collector in Figure 56. This configuration does not need a metal-to-glass seal to maintain vacuum, so it is considered more reliable than the single-walled tube. A heat pipe works by means of a heat transfer fluid inside the heat pipe that vaporizes and rises to a condenser at the top of the heat pipe. Heat is then transferred to water flowing through a manifold and the condensed fluid travels down to the bottom of the heat pipe, where the cycle is repeated.



Apricus, Inc., used by permission

Figure 56. Evacuated tube collectors: double wall with heat pipe¹³

The single-wall tubes are more expensive than flat plates, per unit absorber area. However, the same is not true for the double-wall tubes without metallic inserts. NREL has received three quotes for Sydney-style evacuated tubes at less than \$5/ft² of active area; one quote was slightly less than \$3/ft²; this is one third to one fifth the high-volume wholesale cost of good flat-plate collectors. Low cost can be associated with systems using the double-wall evacuated tubes for thermosiphon systems. These systems can be adapted to the U.S. market by adding a HX to the unpressurized tank (to carry pressurized water), and separating the storage from the tubes and placing it in the attic (to improve the aesthetics). Detailed cost analysis has not been done on this proposed system type, but it offers promise of low cost.

4.2.3 Freeze Concern for Cold Climate Thermosiphons

There are currently no U.S. cold-climate thermosiphons, because of the risk of freeze damage to the collector and to the pressurized, potable-water piping. These two issues must be resolved for viability of the cold climate thermosiphon. The collector can be freeze protected using a glycol loop with immersed solar-loop HX (SolaHart had such a system), or by using brine in collector/storage in a direct solar loop to eliminate the solar loop HX but necessitate all-polymer construction. These are two possible solutions to the collector freeze issue.

The more challenging barrier is the pipe freeze issue. Previous research has developed and tested workable solutions to this problem (Burch et al. 2005; Darbahehti et al. 1999). It is necessary to have primary freeze protection, which keeps the pipes unfrozen and water flowing when properly functioning, and a fail-safe backup to prevent damage if the primary method fails. An appropriate fail-safe backup is PEX pipe, certain brands of which can be freeze-thaw cycled indefinitely (NAHB 2006).

Primary freeze protection methods include FPVs (as in Figure 57), a natural convection loop in supply/return pipes circulating tank heat or room heat, and vacuum insulation. The circulation of tank or room heat has been previously modeled and tested successfully in isolation, but has not been demonstrated in complete systems. Vacuum insulation can be

¹³ [Apricus double-wall heat pipe](#)

used with either of the first two thermal approaches to lower the flow rates and parasitic energy loss, although it may not be suitable in isolation due to the potential for extended vacation/no-draw periods. It may likely be too expensive in the near term, although membrane-based vacuum construction has potential for low cost. On the basis of the previous research, it is believed that the collector and pipe freeze issues are resolvable.

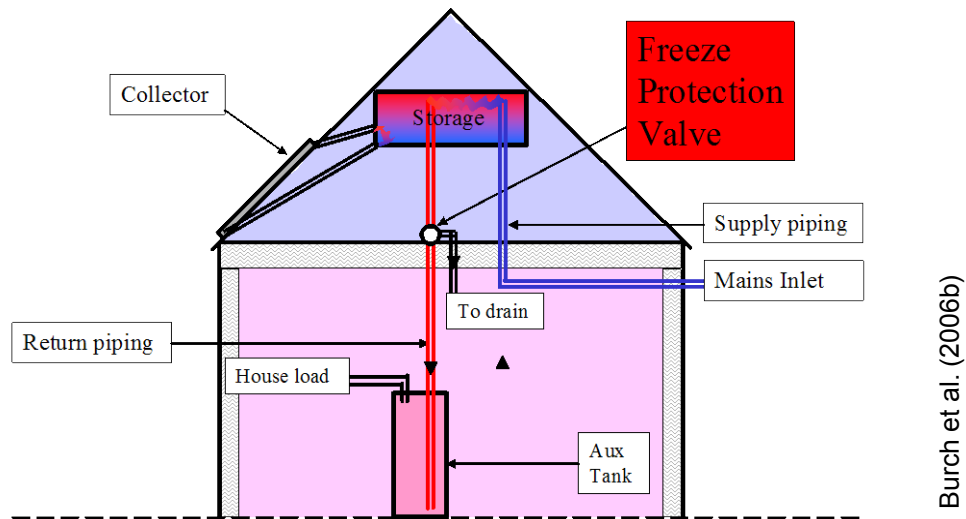

Figure 57. Low-cost thermosiphon configuration, with a direct collector loop, membrane storage in the attic, load-side HX, and PEX supply/return piping with a FPV as primary freeze protection

Although freezable PEX piping is an adequate fail-safe backup, it must be protected from high temperatures. PEX approved under ASTM F877 can be exposed indefinitely at 180°F at 150 psi, but cannot be exposed to temperatures at 210°F for more than 48 hours at that pressure. Two means to protect the pipe are: (1) system overheat protection, which limits temperatures to 180°F or lower (such as thermochromic coating in the collector); and (2) tempering valve set at approximately 170°F at the HX exit before entering the PEX pipe. No data are available on the burst resistance of PEX pipe at higher temperatures, near 212°F.

4.3 Research and Development Priorities

The pathways presented indicate that an installed system cost of about \$1,000 cannot be met by substituting low-cost components in glycol or drainback systems. To reach this goal, it is necessary to use a cold-climate thermosiphon type. It is also necessary to develop low-cost components to use in cold-climate thermosiphons and other system types with low-cost potential. The R&D needs are prioritized as described in Table 9, from high (level 1) through medium (level 2) to low (level 3).

Table 9. R&D Priorities for Low-Cost SWHs

Priority Level	Description
Level 1: High Priority	High cost reduction (~\$1,000), needed in most system concepts
Level 2: Medium Priority	Moderate cost reduction (\$500–\$1,000), or not needed in all system concepts
Level 3: Low Priority	Low-cost reduction potential (< \$500), or not needed in all system concepts, or not easy to achieve without achieving low cost first

4.3.1 Materials Testing: Priority 1

For polymer film glazings and absorber materials, work is needed to:

- Identify candidate low-cost UV-protected polymer film materials.
- Test the best glazing candidates for UV and impact durability.
- Test the best absorber candidates for UV (assuming they passed the glazing test) and temperature tolerance.

Manufacturers may choose to use rigid glazings and absorber materials. Although some of these materials have been previously tested with various coatings, additional materials and coatings may be of interest and demand UV and impact durability testing.

4.3.2 Polymer Components: Priorities 1 and 2

4.3.2.1 Polymer Heat Exchangers: Priority 1

The polymer HX is necessary to avoid the high cost of a copper HX (more than \$250 direct cost). Although specialty polymer HXs are available, they are generally made from engineering polymers that resist corrosion well, are low volume, and have high cost (Davidson et al. 2007). Polymer processors and others should be contracted to design and build prototypes of these HXs.

4.3.2.2 Polymer Tank: Priority 1

Except for the nonseparable polymer film thermosiphon, all the examples hypothesize use of an unpressurized polymer tank separate from the collector. The water containment can be from rigid materials (e.g., the rotomolded PE tank of Solar Tank Works), or can be made with thin membranes (e.g., the soft tank of SolarTechnics). The latter is important to have a low-weight, compact package to install in attics. Polymer processors with polymer film membrane expertise should be contracted to design and build prototypes of these tanks.

4.3.2.3 Polymer Piping: Priority 2

Certain brands of PEX have been shown to be freeze tolerant (NAHB 2006). It is necessary to extend those tests to cover the most common PEX piping for potable hot water (we are aware of four major suppliers at this time). It is also necessary to determine the burst resistance at higher temperatures, including at or slightly above boiling. Although there are standards for these tests, suppliers have shown little interest in extending the

temperature range, and test data are not available in the temperatures of interest. Burst tests should be carried out for the pipes shown to be freeze tolerant.

4.3.3 Other Component Research: Priorities 2 and 3

4.3.3.1 Integrated Valving Package: Priority 2

An integrated valve package is a factory-built construction of all the valving needed near the solar and auxiliary tanks, including pressure relief, bypass/isolation valving, and fill valves. In all the examples, it was assumed that an integrated valve package was used to reduce installation costs. Although the European manufacturers have already fielded such packages, these units have not been made for U.S. products. Injection molding can be used with a single shot to connect valves placed in the mold to reduce hardware costs.

4.3.3.2 Mounting Methods: Priority 3

Typical mounting hardware (and its installation) costs more than \$100. In previous low-cost R&D, collectors were laid directly on the roof. Further research is needed to determine if this method causes mold problems. If so, the air channels under the collector must be modified to allow more airflow between the collector and the roof. Tie-down straps need to be tested to ensure wind resistance.

4.3.3.3 Installation Costs: Priority 3

Installation costs are reduced mainly by simplifying the systems, reducing weight of collectors and tanks (easily carried by one person), using continuous integrated PEX piping, and using integrated valve packages. Once these advanced components are available, some research will be needed to further streamline the installation. The installation goal would be to have a crew of two put in two systems in an 8-hour period, including travel and setup/cleanup time.

4.3.4 Soft Costs Research: Priority 3

It is important to reduce the soft costs, which include permitting, marketing, and distribution system costs. These costs can total \$2,000–\$3,000 for today's systems. We put little emphasis into reducing these costs in this roadmap, not because they are not important, but because the soft costs generally will decrease only when the system volume is very high and cost is very low. Marketing costs for retrofits average around \$1,500, because it is very difficult to sell a system that has more than a 10-year payback. When the payback is 5 years or less, the marketing cost will decrease, because systems will be available in big box stores and on plumbers' trucks. High volume will also reduce the layers of distribution and associated high overhead endemic to today's industry. Permitting costs can be lowered by working with code jurisdictions to streamline the process and eliminate these costs altogether for certain standard systems with qualified installation firms. The solar heating program should follow the lead of the PV program, which is working in a very similar way on the permitting costs for residential PV installations.

5 Low-Cost Solar Water Heating Challenges and Barriers

5.1 Market Challenges and Barriers

Conventional electric and gas-fired storage WHs dominate the U.S. residential WH market, accounting for 93% of the residential WHs sold in the United States (EIA 2005). Most U.S. homeowners do not give much thought to the method or fuel used to heat their water until their current WH stops working, and then they replace it as quickly and cheaply as possible. This presents market challenges and barriers for current SWH technologies, which are summarized in Table 10.

Table 10. Low-Cost SWH Market Challenges and Barriers

Market Barriers	Description
Cost	Many SWH systems are available in the marketplace, but are too expensive for widespread adoption.
Permitting/code limitations	Permits add significant costs. Codes, covenants, and restrictions may not permit solar systems on homes and commercial buildings.
Contractor availability	Trained and licensed contractors for installing SWH systems are not readily available in some locations.
Consumer awareness	Consumers have limited knowledge about the performance, costs, and benefits of SWH systems.

SWHs are significantly more expensive to purchase and install than conventional WHs—up to 10 times higher in some retrofit situations. Driving down this first (purchase) cost is essential to improving the economics and marketability of SWHs.

Based on the SWH break-even costs against natural gas shown in Figure 13, Table 11 displays how the percentage of U.S. customers increases as the total installed cost of the SWH system decreases. This shows that if the installed cost of a SWH system were reduced to \$2,500, 50% of the U.S. market would be at break-even cost with natural gas. If the cost were reduced further to \$1,000, the market percentage would increase to 95%.

Table 11: Percentage of U.S. Market at Break-Even Cost Versus Natural Gas

SWH System Cost	Percent at Break-Even (Natural Gas)
\$7,000	0.04%
\$5,000	0.8%
\$2,500	50%
\$1,000	95%

Based on the break-even costs against natural gas, Figure 58 shows how the available market for SWH systems in the northern “cold climate” states increases as the total installed cost of the system decreases. “Cold climate” was here taken as north of the Mason Dixon line (extended through to the west coast, and counting California as half cold and half hot. For SWH systems with installed costs at \$1,000, the number of households in the northern gas market is approximately 34 million, which represents 30% of all U.S. homes.

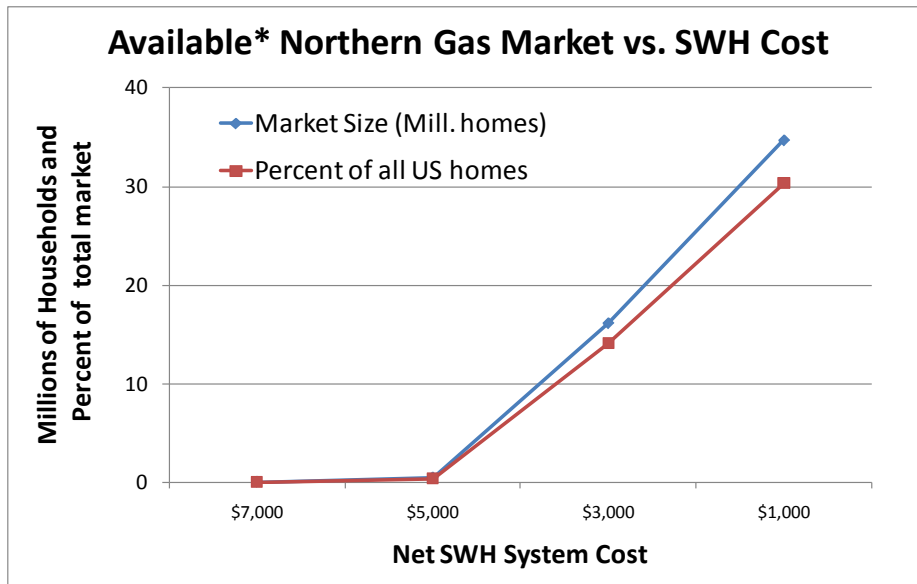

Figure 58. U.S. water heating available market versus SWH system cost
 * Available market = Net SWH system cost below breakeven cost for that area

Installing SWHs in existing homes can be hampered by building codes and community regulations that are outdated or do not make provisions for nonconventional technologies. Navigating through and adhering to these codes and regulations adds a layer of complexity to the design, installation, and permitting processes that purchasers of conventional WHs do not face. In addition, some community covenants or homeowner association rules prohibit the installation of SWHs directly, essentially eliminating potential markets.

Contractor availability is another market barrier. Due to the limited SWH market, the number of experienced installers is also limited in any given location. Highly qualified installers probably have little competition, leading to higher overhead and marketing costs. Also, the installer can charge more for his services. There are also less standardization and more inexperienced installers entering the field, resulting in increased installation times and potential rework, both of which would result in higher installation costs.

Poor design, faulty components, poor installation, and lack of maintenance for early generation SWH systems often caused reliability and durability issues. These problems have largely been rectified; however, they resulted in a dwindling residual marketplace and distrust of the technology that heightens builder, installer, and consumer sensitivity to durability and reliability issues. Increasingly, today's likely purchasers are unaware of product issues dating from 25 to 30 years ago, elevating lack of consumer awareness to a much more significant barrier to increased market penetration.

5.2 Technical (Nonmarket) Challenges and Barriers

The main research pathways in low-cost SWH R&D address reducing material costs while maintaining or improving energy performance and reliability. One pathway option mentioned in this roadmap is to replace copper and glass with polymers. The other pathway option is a complete redesign of the system, resulting in a passive thermosiphon design that incorporates either polymer film technology or evacuated glass tubes. The

technical challenges and barriers associated with these pathways were mentioned in Sections 4.1 and 4.2 and are summarized in Table 12.

Table 12. Low-Cost SWH Technical Challenges and Barriers

Technical Barriers	Description
System performance	Maintaining system performance levels comparable to conventional systems made of copper, glass, and aluminum must be a priority when reducing the cost of SWH systems.
Polymer components	R&D is needed to develop and test polymer components for SWH systems. This includes polymer collectors, storage tanks, and HXs.
Overheat protection	Collectors must withstand stagnation temperatures of 250°–450°F.
Freeze protection	Innovative solutions to freeze protection are needed to ensure reliably in cold climates.
PEX piping	PEX has been shown to be freeze tolerant, but testing is needed to ensure high temperature reliability.
Polymer films	Attaching and processing polymer films need to be developed. Lifetime testing of polymer films for ensuring UV protection is also needed.
Unpressurized storage	Developing and engineering design concepts, testing materials, building prototypes, and optimizing manufacturing is needed.
Integration with HPWHs	Integration of SWH systems with HPWHs requires design modifications and development of control strategies.

5.3 Strategies/Pathways to Overcoming Challenges/Barriers

To develop lower cost SWH systems, the low-cost SWH R&D activity typically works in collaboration with industry partners in a stage gate process of R&D phases:

1. Concept Generation/Exploratory Research—Identification of general system configurations that could conceivably reach the project’s cost goal
2. Concept Development/Prototype Test—Development of detailed designs for promising concepts, and construction and evaluation of prototypes
3. Advanced Development/Field Test—Development of second-generation prototypes, and conducting limited field testing and evaluation
4. Engineering/Manufacturing Development—Refinement of efficient manufacturing methods, construction of third-generation units, and evaluation of “near-final” systems in “real-world” applications.

At the end of each phase, progress is evaluated, compared to strategic goals and performance targets, and a “go/no go” decision is made regarding moving on to the next phase. DOE, NREL, and industry followed this multiyear process to develop low-cost SWH systems for warm climates (Burch et al. 2005). This activity has resulted in the commercialization of a polymer-based SWH product by one of the largest U.S. solar thermal manufacturers, as described in Section 2.3.1.

To meet the cost, performance, and reliability targets outlined in the low-cost SWH roadmap, the R&D strategies summarized in Table 13 are needed. Achieving these targets

will require innovative solutions to an already mature technology. SWH systems need to be simplified, to reduce the number of components, and as a result, the installation and maintenance costs. New materials need to be researched and analyzed. Polymer materials are extremely promising and will significantly reduce the cost and weight of a collector, which will simplify installation and reduce installation costs. Evacuated solar tube collectors are also a promising technology that incorporates a passive system design. It is believed that industry partnerships will enable the success of such innovative systems.

Performance and reliability must also be maintained. Performance can be enhanced relative to existing designs using selective coating and optimizing component sizing. Incorporation with HPWHs is also an option for future innovation. Technical barriers such as protection from stagnation and freeze conditions need solutions to ensure reliable and safe operation. Extensive testing is also required, including materials testing and accelerated collector durability testing.

Table 13. Low-Cost SWH Targets and R&D Strategies To Achieve Program Targets

Cost	<ul style="list-style-type: none"> • Industry partnerships to develop innovative low-cost SWH systems that can achieve broad market impacts • Polymer HXs and integrated polymer piping for lower cost BOS • Passive SWH systems to eliminate the cost of pumps and controls • Polymer or membrane tanks for lower cost thermal storage • Polymer absorbers and polymer glazings for lower cost SWH collectors • Evacuated glass solar tubes for lower cost SWH collectors • Lightweight SWH collectors and systems for lower cost installation • Fewer components to minimize onsite assembly for lower cost installation
Performance	<ul style="list-style-type: none"> • Innovative SWH system concepts to maintain system performance (35%–40% source energy saving) over conventional natural gas WHs in cold climates • Larger format collectors for greater performance and economies of scale in commercial/industrial application • Selective surface polymer absorbers for greater collection efficiency • Integration with HPWHs for higher performance
Reliability	<ul style="list-style-type: none"> • Accelerated solar radiation exposure and high temperature testing for more reliable, longer lasting SWH absorbers and glazings • Simple and reliable overheat protection and freeze protection • Innovative anti-freeze fluids to meet freeze and cost requirements • Passive SWH systems to eliminate maintenance of pumps and controls • High temperature and pressure testing for polymer HXs and piping • Quality assurance through reliability and installation standards

5.4 Industry Feedback

Industry feedback was received during the Low-Cost Solar Water Heating webinar that took place in July 2011 and during follow-up discussions with webinar attendees and key industry players. Figure 59 shows one of the polling questions from the webinar. Based on this feedback, more than half the respondents believe that technical and financial support from NREL and DOE would be beneficial to them in the future. A significant fraction (33%) indicated that only technical support would be beneficial.

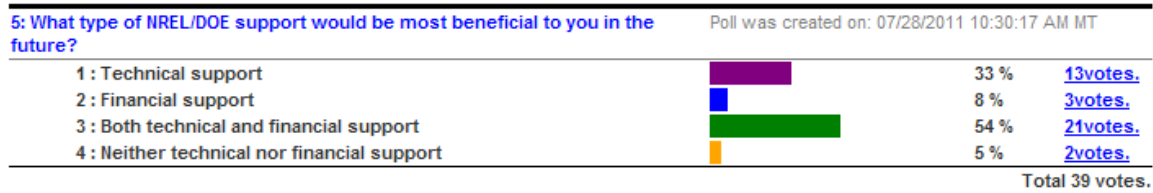

Figure 59. Polling results from Low-Cost Solar Water Heating webinar

Direct industry feedback was received as a result of the webinar. Below is a quote from the Solar Energy Industries Association, which represents the existing SWH industry.

“Our feedback from the industry is that they would like to see the DOE focus on programs for workforce development, consumer awareness, regulations/certification, demonstration projects, and financial incentives and policy items for SHC.” – Katherine Stainken, Solar Energy Industries Association

Recent polling results released from the Solar Energy Industries Association indicate that SWHs are perceived positively by Americans, primarily because of the potential for job creation (SEIA 2011b). Three survey results that are particularly important to the low-cost SWH activity are:

“Positive perceptions of ‘solar water heating systems’ exceed negative perceptions by more than 10 to 1 (48 percent to 4 percent).”

“Solar energy is now considered to be the energy source most deserving of U.S. government support – outdistancing natural gas, oil, nuclear, and even wind energy.”

“‘The cost of purchasing the system’ (72 percent) and ‘the cost of maintaining the system’ (56 percent) are the top two concerns for residents in all regions and across key demographic/partisan groups.”

Feedback was also received from a solar consultant in the Northeast, who has been in the business of designing and installing thermal systems for almost 40 years. His comments include:

“A solar domestic water heater that is as low in cost as your target will almost certainly have to be natural circulation or batch (ICS).”

“If you are able to come up with a cold climate system that is installed for between \$1,000 and \$3,000 and the installer and everyone else along the line can make a profit, you’ll have a real winner.”

“An attraction to any sort of packaged system is the labor savings on site. Design the system to minimize the on-site related work. Plop it on the roof, screw it in

*place, connect the water lines, add water, and the system is off and running”-
Everett Barber Jr., Sunsearch, Inc.*

In general, the feedback demonstrates support and interest in the low-cost SWH project. In addition to industry feedback, a third-party evaluation was performed by Navigant Consulting, Inc. to determine if low-cost systems were available in leading markets around the world, and if so, what opportunities could be developed in the United States. Based on these findings, Navigant concluded that:

*“[The] most promising innovations for reducing system cost have performance tradeoffs and may only reduce **overall SWH system** cost by 10-20%. Reducing **overall system cost** by 10-20% will have a limited impact on reducing the system payback and therefore a limited impact on adoption of SWH systems in the US market.” – Navigant Consulting, Inc.*

Because of the limited success in finding low-cost SWH systems that would be applicable in the U.S. market:

“Navigant recommends research into revolutionary new approaches to solar water heating. Absent dramatic changes to policy, building codes or energy costs, such new approaches are the only viable mechanism to drive costs down to economically attractive levels on a sustainable basis” – Navigant Consulting, Inc.

5.5 Low-Cost Solar Water Heating R&D Plan

R&D is essential to the success of low-cost SWH systems that can compete with natural gas WHs. Figure 60 shows the overall project timeline and the R&D targets broken down into three categories: Equipment, Optimized System Design and Advanced O&M, and Policy & Markets.





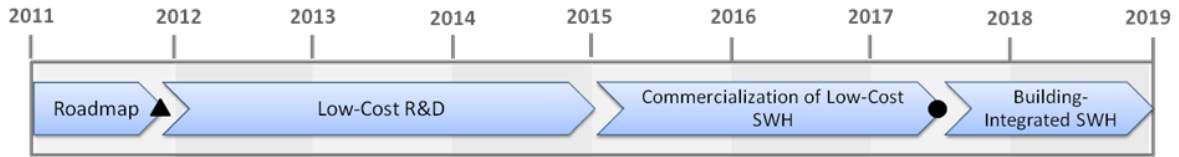

Successful completion of this R&D plan will lead to the development of one or more low-cost SWH systems that can compete with natural gas WHs in cold climates. This R&D is best performed through industry partnerships, where industry can lead the design efforts with technical support from DOE.

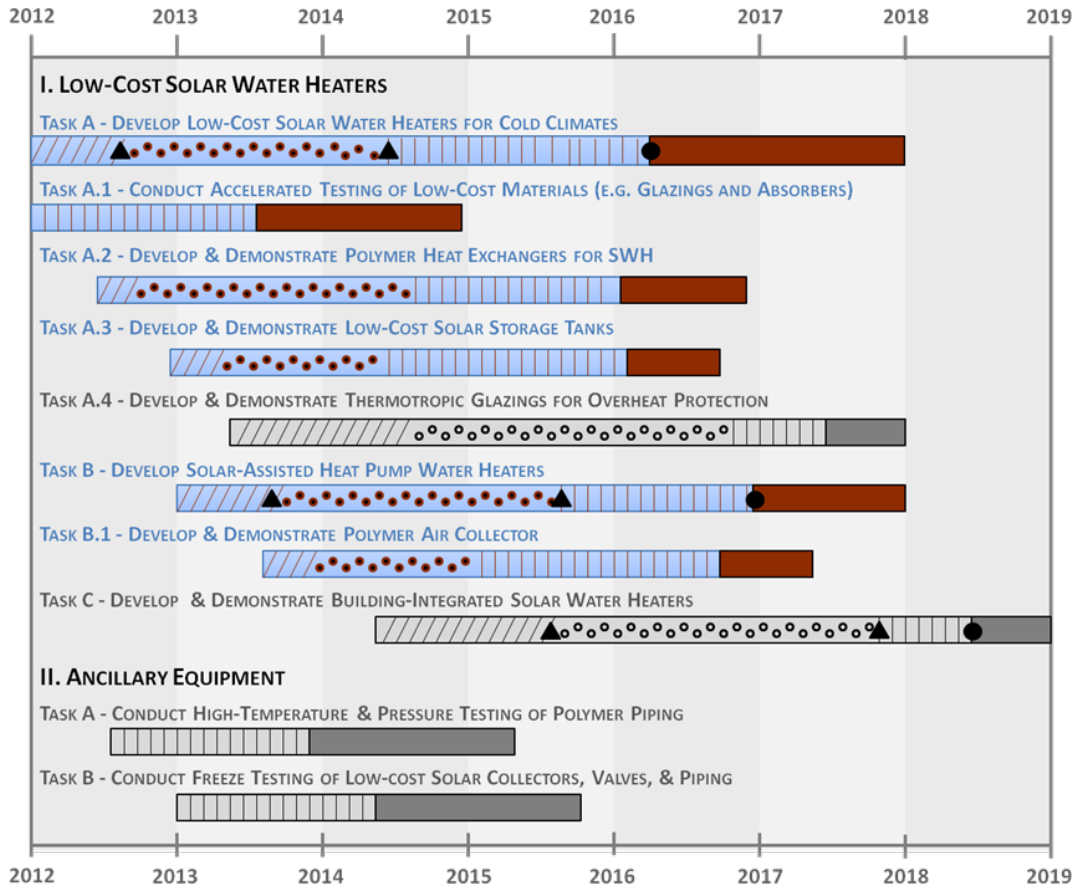
LOW-COST SOLAR WATER HEATING PROJECT TIMELINE

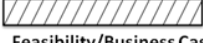
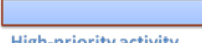

R&D TARGET 1: EQUIPMENT



LEGEND	
TIMELINE	PRIORITY RATING
	
Feasibility/Business Case	High-priority activity
	
Design & Development	Lower-priority activity
	
Testing & Validation	Key Decision Point
	
Field Testing & Commercialization	Key Milestone

R&D TARGET 2: OPTIMIZED SYSTEM DESIGN, ADVANCED OPERATION & MAINTENANCE

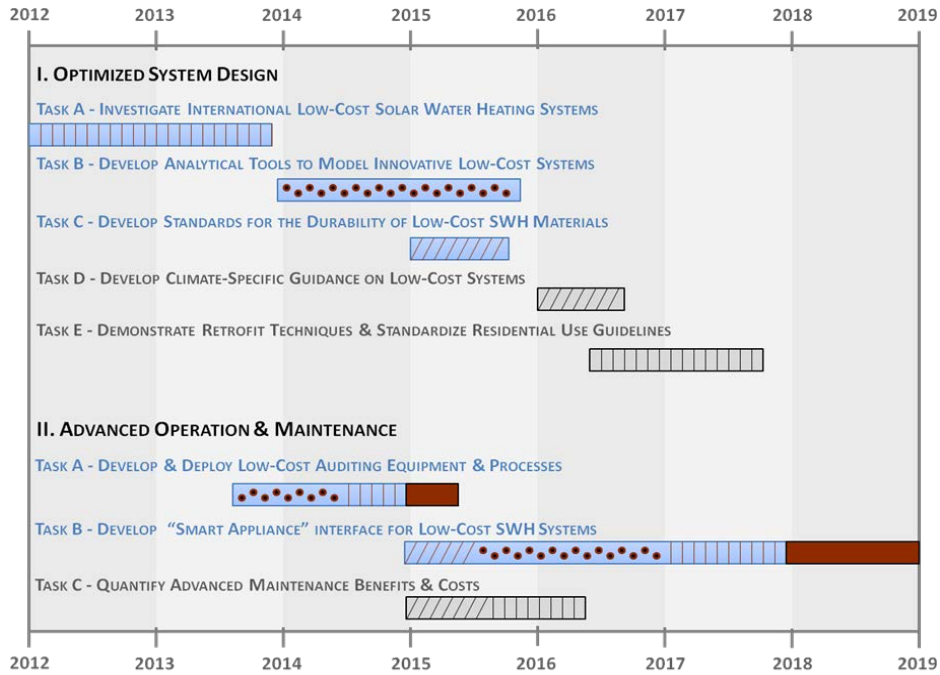

R&D TARGET 3: POLICY & MARKETS

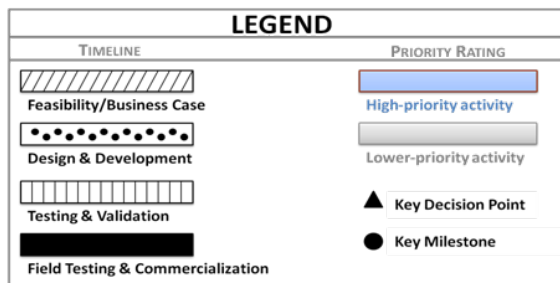
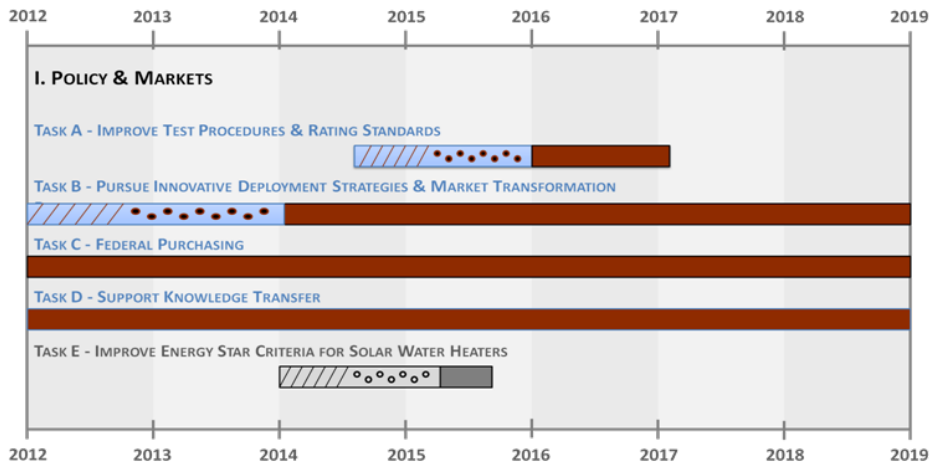

Figure 60. Residential low-cost SWH research activity—project and R&D timelines

The *Low-Cost Solar Water Heating R&D Roadmap* is an extension of the *Water Heating Technologies Roadmap* that was provided to DOE in September 2011. In the *Water Heating Technologies Roadmap*, one key R&D initiative is to “Develop super-high-efficiency WHs (next generation).” In this category, the development of gas-fired and advanced electric HPWH technologies is expanded into work breakdown structures (WBS) that outline the R&D needed for each high-efficiency option. High-efficiency and lower cost SWHs are also mentioned under this initiative, but a WBS is not given in the *Water Heating Technologies Roadmap*. Figure 61 shows the suggested WBS for low-cost SWH R&D. It is believed that working with industry to develop innovative solutions, such as the pathway options presented in this roadmap, can lead to commercialization of low-cost SWHs by 2018.

WORK BREAKDOWN STRUCTURE: LOW-COST SOLAR WATER HEATERS

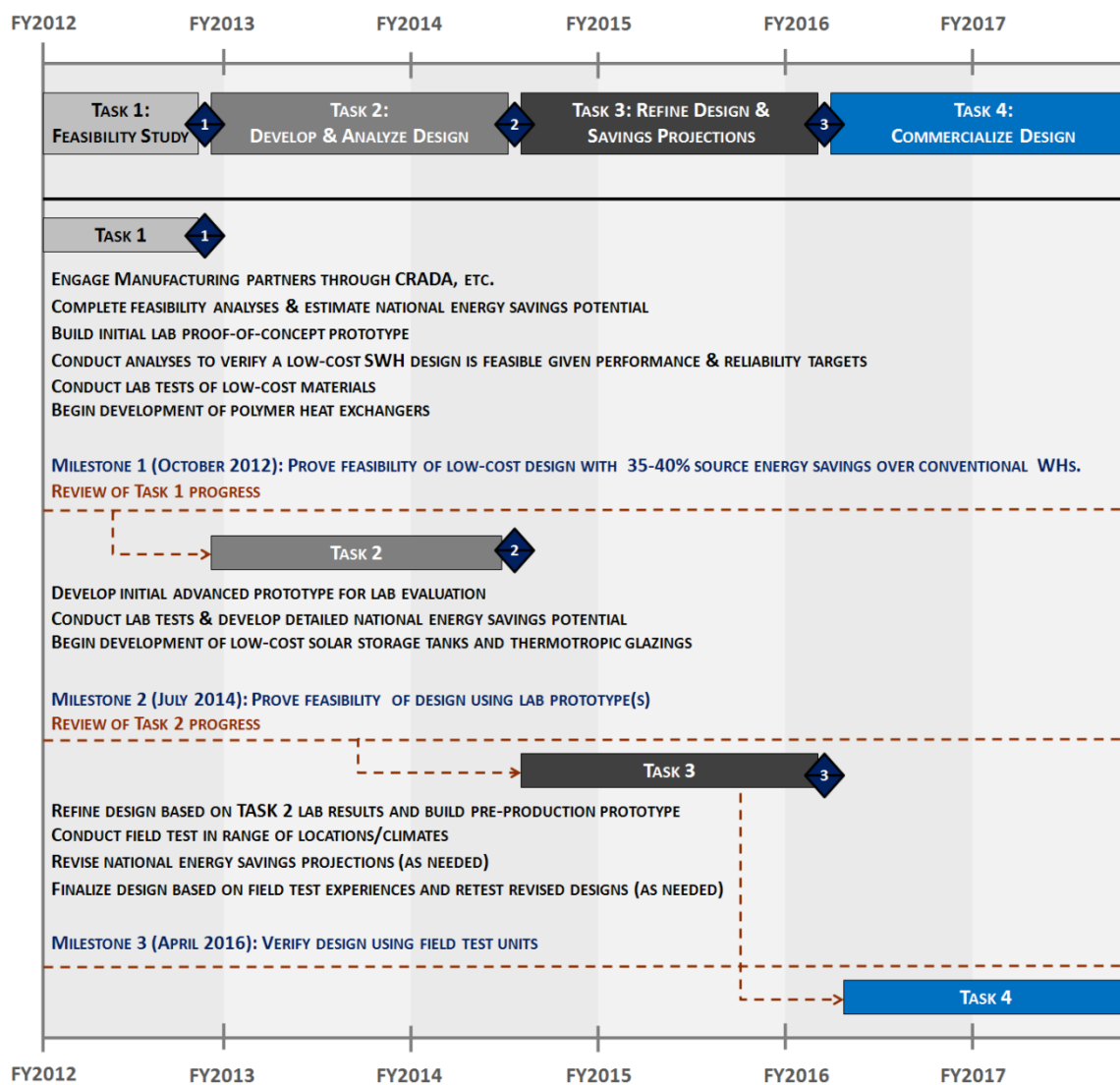

Figure 61. WBS for low-cost SWHs

A suggested WBS is also provided for a solar-assisted HPWH (see Figure 62). Research indicates that HPWHs provide significant energy savings compared to electric resistance heating, but that solar energy can improve the efficiency of HPWH technology. This is because HPWHs perform best in a warm ambient environment. Therefore, incorporating low-cost solar technologies as a preheat for existing HPWHs creates an opportunity to improve the EF of HPWH technology.

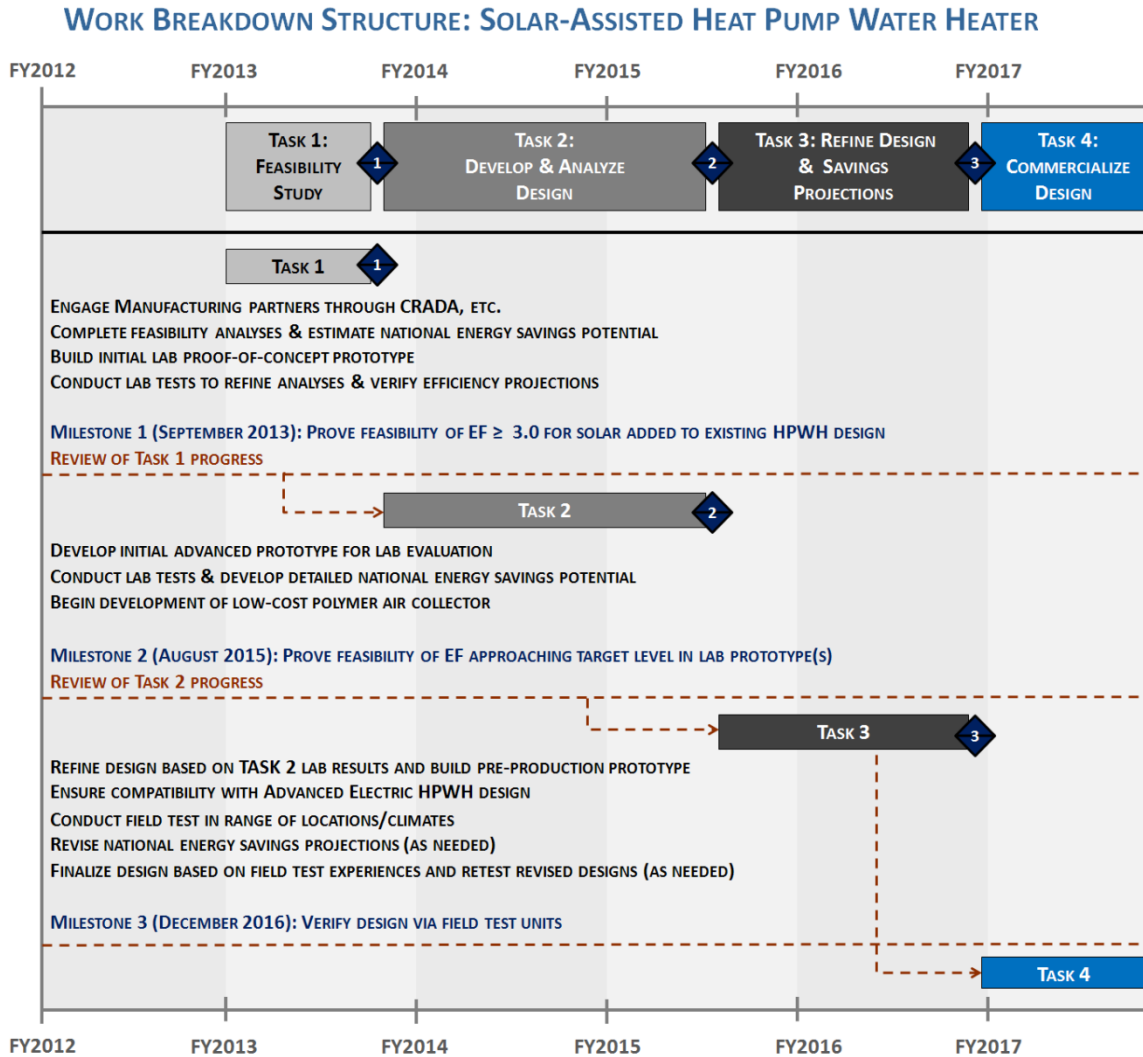

Figure 62. WBS for solar-assisted HPWHs

6 Summary and Conclusions

SWHs are a mature technology, and reliable systems are available in niche markets across the United States with installation costs of \$5,000–\$10,000. Despite the effectiveness of this technology, SWHs make up less than 1% of the U.S. water heating market, a fact that can be attributed to the high installed cost of an SWH system. Based on analysis presented in this roadmap, the greatest opportunity for expanding the SWH market is to develop technology that is cost competitive with natural gas WHs in cold climates. This roadmap outlines a near-term strategy to reduce the installed system costs and maintain the overall energy savings associated with SWH technology.

For SWHs to compete with natural gas WHs in the U.S. market, the installed cost would need to be reduced to \$1,000–\$3,000 per system. Low-cost SWHs are used throughout the world, and although not all the systems used in other countries are applicable to the U.S. market, some lessons can be learned from the significant growth of SWH technologies in Europe and Australia: (1) long-term policy support of solar thermal incentives enables the industry to plan long term and invest in market growth accordingly; and (2) public education campaigns that raise consumer awareness and point out the benefits of solar thermal systems help create customer demand.

Four cost factors were identified that, if addressed through R&D, would have the largest impact on reducing the installed cost of SWH systems: technology choice, design, building SWH preparation, and installer costs. Of these, this roadmap addressed the impacts of technology choice and design. Two possible pathway options were presented that show how innovative technologies and design changes can reduce cost. One pathway option is to replace copper and glass components with polymers. Polymer technology has the potential to reduce equipment cost considerably. This design change also significantly reduces the weight to the system, which will reduce installation time and therefore cost.

Although the polymer pathway option is a step in the right direction, it probably will not reduce the system cost to the target goals presented in this roadmap. This point was also made by Navigant Consulting, Inc., whose third-party evaluation concluded that:

“...a fundamentally new approach to solar water heating, beyond standard cost reduction strategies for flat plate collectors, is probably required for solar water heating to achieve substantial market success.” – Navigant Consulting, Inc.

To achieve a significant reduction in cost, more radical designs are needed. The other pathway option presented in the roadmap is a complete redesign of the system, resulting in a passive thermosiphon design that incorporates either polymer film technology or evacuated glass tubes. By changing the technology choice to a thermosiphon system, the SWH becomes considerably less complex compared to an indirect system. The cost is reduced because components such as pumps and sensors are eliminated. Having fewer system components also makes it easier to install and more reliable. It is believed that development of this thermosiphon pathway option will result in an SWH system that is cost competitive with convectional systems. However, there are probably other pathways to a low-cost solution.

In the end, R&D is needed to overcome the market and technology barriers identified in this roadmap. Market barriers include permitting/code limitations, contractor availability, and consumer awareness. These “soft” costs make up a significant portion of the installed cost of an SWH system and need to be considered in addition to component costs. These issues can be addressed by implementing programs that focus on workplace development, enabling demonstration projects that showcase technologies, and streamlining regulation and certification processes. It is also important that policies are put in place that promote the technology and that financial incentives are kept in place as the market is established.

The technical challenges include addressing freeze and overheat protection concerns, developing and testing polymer materials (including PEX and polymer films), developing unpressurized storage, and maintaining system performance. It is believed that these barriers can be overcome and that the strategies presented in this document are best executed through partnerships with industry, who can lead the design efforts with technical support from DOE.

Due to the limited scope of this roadmap, several important solar thermal applications were not addressed. Specifically, the topics of solar heating and cooling for residential and commercial applications were not included. This is not to say that such applications are not important and warrant research and development in the future. These applications should be considered for future funding.

7 References

- ACEEE. (2006). The 2006 Summit on Emerging Technologies in Energy Efficiency. October 26–27, 2006, Long Beach, CA. American Council for an Energy-Efficient Economy.
- ACHI. (2011). Historical Statistical Data. Arlington, VA: Air-conditioning, Heating, and Refrigeration Institute. www.ahrinet.org/App_Content/ahri/files/Statistics/Historical%20Data%20pdfs/Res_Water_Heaters.pdf
- Berner, J. (2011). “Small Country with Big Ideas.” Sun & Wind Energy. Volume 7/2011. Pages 60-63.
- Blair, N.; Mehos, M.; Christensen, C.; Cameron, C. (2008). “Modeling Photovoltaic and Concentrating Solar Power Trough Performance, Cost, and Financing with the Solar Advisor Model.” Presented at SOLAR2008 – American Solar Energy Society (ASES), NREL/CP-670-42922. www.nrel.gov/docs/fy08osti/42922.pdf
- Burch, J.; Christensen, C.; Merrigan, T.; Hewett, R.; Jorgensen, G. (2005). “Low-Cost Solar Domestic Hot Water Systems for Mild Climates.” Golden, CO: National Renewable Energy Laboratory. NREL/CP-550-371056. www.nrel.gov/docs/fy05osti/37106.pdf
- Burch, J. Christensen, C., Salasovich, J., Lorard, B., Scholten, B. June 2000. “Cost-Benefit Modeling of Solar Domestic Hot Water Systems.” Proceedings of the ASES Annual Conference.
- Burch, J.; Heater, M.; Brandemuhl, M. Krarti, M. (2006a). “Northward Market Extension for Passive Solar Water Heaters by using Pipe Freeze Protection with Freeze-Tolerant Piping.” In Proceedings Solar 2006, American Solar Energy Society, Denver, CO. www.nrel.gov/docs/fy06osti/39664.pdf
- Burch, J., Heater, M., Brandemuhl, M., Krarti, M. (2006b). “Pipe Freeze Prevention for Passive Solar Water Heaters Using a Room-Air Natural Convection Loop.” Presented at Solar 2006, Denver, CO, July 2006. NREL/CP-550-39722. www.nrel.gov/docs/fy06osti/39722.pdf
- Burch, J.; Hillman, T. Salasovich, J. (2004). *Cold-Climate Solar Domestic Water Heating Systems: Cost/Benefit Analysis and Opportunities for Cost Reduction*, Provided to DOE September 2004, available from kate.hudon@nrel.gov.
- Burch, J., Salasovich, J. (2005). “Water Consumption from Freeze Protection Valves for Solar Water Heating Systems.” Presented at the ISES Solar World Congress, Orlando, FL, August 2005. NREL/CP-550-37696. www.nrel.gov/docs/fy06osti/37696.pdf
- Cassard, H.; Denholm, P.; Ong, S. (2011a). “Break-Even Cost for Residential Solar Water Heating in the United States: Key Drivers and Sensitivities.” Golden, CO: National Renewable Energy Laboratory. NREL/TP-6A20-48986. www.nrel.gov/docs/fy11osti/48986.pdf

Cassard, H.; Denholm, P.; Ong, S. (2011b). “Technical and Economic Performance of Residential Solar Water Heating in the United States.” *Renewable and Sustainable Energy Reviews* 15(8):3789–3800.

Consumer Reports. 2010. “Water Heaters: Cutting your hot-water bill just got easier.” www.consumerreports.org/cro/magazine-archive/2010/october/appliances/water-heaters/overview/index.htm

Darbaheshti, M.; Burch, J.; Gawlik, K.; Johnson, T. (1999). “Freeze Protection for Potable Water Piping Using Natural Convection Loop.” In Proceedings ASES 1999, ASES, Boulder, CO.

Davidson, J.; Mantell, S.; Francis, L. (2007). “Thermal and Material Characterization of Immersed Heat Exchangers for Solar Domestic Hot Water.” *Advances in Solar Energy*, vol. 17. D. Y. Goswami, ed., American Solar Energy Society, pp. 99–12.

Davis Energy Group. (2008). SunCache Solar Water Heating. Davis, CA. www.davisenergy.com/technologies/suncache2.php

Denholm, P. (2007). *The Technical Potential of Solar Water Heating to Reduce Fossil Fuel Use and Greenhouse Gas Emissions in the United States*. Golden, CO: National Renewable Energy Laboratory. NREL/TP-640-41157. www.nrel.gov/docs/fy07osti/41157.pdf

Denholm, P.; Drury, E.; Margolis, R. (2009). *The Solar Deployment System (SolarDS) Model: Documentation and Sample Results*. Golden, CO: National Renewable Energy Laboratory. NREL/TP-6A2-45832. www.nrel.gov/docs/fy10osti/45832.pdf

DOE. (1998). “10 CFR Part 430 Energy Conservation Program for Consumer Products: test Procedure for Water Heaters.” Washington, D.C.: U.S. Department of Energy. Federal Register Vol. 63, No. 90.

DOE. (2010a). Obama Administration Announces Plans to Install New Solar Panels on the White House Residence. Washington, D.C.: U.S. Department of Energy. <http://energy.gov/articles/obama-administration-announces-plans-install-new-solar-panels-white-house-residence>

DOE. (2010b). Residential Heating Products Final Rule Technical Support Document. Washington, D.C.: U.S. Department of Energy. http://www1.eere.energy.gov/buildings/appliance_standards/residential/heating_products_fr_tsd.html

DOE. (2010c). ENERGY STAR Water Heater Market Profile. Washington, D.C.: U.S. Department of Energy. www.energystar.gov/ia/partners/prod_development/new_specs/downloads/water_heaters/Water_Heater_Market_Profile_2010.pdf

DOE. (2011a). Buildings Energy Data Book. Washington, D.C.: U.S. Department of Energy. <http://buildingsdatabook.eren.doe.gov/ChapterView.aspx?chap=2>

- DOE. (2011b). Department of Energy FY 2012 Congressional Budget Request. www.cfo.doe.gov/budget/12budget/Content/Volume3.pdf
- DOE. (2011c). Utility Solar Water Heating Initiative. Washington, D.C.: U.S. Department of Energy. http://apps1.eere.energy.gov/buildings/ush2o/projects/commercial_solar_thermal_projects.cfm?sortby=collectorArea
- DOE. (2011d). Building Technologies Program Vision and Mission. www1.eere.energy.gov/buildings/vision.html
- DOE. (2011e). Department of Energy Strategic Plan. Washington, D.C.: U.S. Department of Energy. <http://energy.gov/management/downloads/departement-energy-strategic-plan-may-2011-print-quality>
- DOE. (2011f). SolOpt takes the Guesswork out of Optimizing Solar Technology on Rooftops. Washington, D.C.: U.S. Department of Energy. www.eereblogs.energy.gov/tap/post/SolOpt-takes-the-Guesswork-out-of-Optimizing-Solar-Technology-on-Rooftops.aspx
- DOE. (2011g). Building America – Resources for Energy Efficient Homes. Washington, D.C.: U.S. Department of Energy. www1.eere.energy.gov/buildings/building_america/climate_zones.html
- Epp, B. (2009). “World Map of Solar Thermal Industry 2009.” www.solrico.com/fileadmin/medien/pdf/2009_world_map_of_flate_plate_collector_manufacturers.pdf
- Epp, B. (2010). International Comparison of Warranty Periods Granted by Collector Manufacturers. Global Solar Thermal Energy Council. www.solarthermalworld.org/node/1047
- Epp, B. (2011). “World Map of Solar Thermal Industry 2011.” <http://www.solrico.com/en/solar-market-research/world-map-2011.html>
- EIA. (2005). *Residential Energy Consumption Survey 2005*, Washington, D.C.: Energy Information Administration. www.eia.doe.gov/consumption/residential/data/2005
- EIA. (2009). *Residential Energy Consumption Survey 2009*. U.S. Department of Energy, Washington, D.C.: Energy Information Administration <http://www.eia.doe.gov/emeu/recs/>.
- EIA. (2010a). Annual Energy Review. Washington, D.C.: U.S. Energy Information Administration. www.eia.gov/totalenergy/data/annual/index.cfm
- EIA. (2010b). Solar Thermal Collector Manufacturing Activities 2008. Washington, D.C.: U.S. Energy Information Administration. www.eia.doe.gov/cneaf/solar.renewables/page/solarreport/solar.pdf
- EIA. (2011). Natural Gas Prices. Washington, DC. Washington, D.C.: U.S. Energy Information Administration. www.eia.gov/dnav/ng/ng_pri_sum_dcu_nus_m.htm

- ENERGY STAR. (2010). ENERGY STAR Partner Products Meeting 2010. www.energystar.gov/index.cfm?c=partners.pt_meetings_archive
- ESTIF. (2007). “Solar Thermal Markets in Europe (Trends and Market Statistics 2006).” Brussels, Belgium: European Solar Thermal Industry Federation. www.estif.org/fileadmin/estif/content/market_data/downloads/Solar_Thermal_Markets_in_Europe_2006.pdf
- FAFCO. (2012). Solar Water Heating. Chico, CA: FAFCO. www.fafco.com/shw/options.aspx
- Fumoso Industrial. (2010). Commodity Polymer Prices. Barcelona, Spain. www.span-pack.com/index.php?option=com_content&view=article&id=56:los-precios-de&catid=74:styrenics&Itemid=91
- Hendron, R.; Engebrecht, C. (2010). *Building America House Simulation Protocols*. Golden, CO: National Renewable Energy Laboratory. www.nrel.gov/docs/fy11osti/49246.pdf
- Hudon, K.; Sparn, B.; Christensen, D.; Maguire, J. (2012). “Heat Pump Water Heater Technology Assessment Based on Laboratory Research and Energy Simulation Models.” *ASHRAE Transactions* vol. 118, part 1.
- IEA. (2011). Solar Heating and Cooling Programme. Cedar, MI: International Energy Agency. www.iea-shc.org/solarenergy/
- Itron, Inc. (2011). *California Center for Sustainable Energy: Solar Water Heating Pilot Program: Final Evaluation Report*. Submitted to California Center for Sustainable Energy, San Diego, CA. <https://energycenter.org/index.php/incentive-programs/solar-water-heating>
- Jorgensen, G. (2005). *Annual Report 2005: Materials Durability*. available from Glenn Strahs at DOE, or from jay.burch@nrel.gov.
- Kitco. (2012). Copper Historical Charts. New York, NY: Kitco Metals, Inc. www.kitco.com/charts/copper_historical.html
- Maguire, J. (2011). *A Parametric Analysis of Residential Water Heaters*. Master’s thesis, Department of Mechanical Engineering, University of Colorado, Boulder, CO. <http://disexpress.umi.com/dxweb#download?&type=pdf&dpubno=1511987>
- Meyers, J.-P. (2011a). “Fantastic Plastics: Revolution or Devolution?” *Sun & Wind Energy*.
- Meyers, J.-P. (2011b). “The Industry is Driven by Material Costs.” *Sun & Wind Energy*.
- NAHB (2006). “Design Guide Residential PEX Water Supply Plumbing Systems.” Upper Marlboro, MD: NAHB Research Center, Inc. www.toolbase.org/pdf/designguides/pex_designguide.pdf

Navigant Consulting, Inc. (2010). “Solar Water Heating Supply Chain Market Analysis.” Prepared for the City of Milwaukee and the National Renewable Energy Laboratory. <http://city.milwaukee.gov/ImageLibrary/Groups/cityMilShines/Documents/2010/SHWSupplyChainFinalReport.pdf>

NREL. (2008). National Solar Radiation Data Base. Golden, CO: National Renewable Energy Laboratory. http://rredc.nrel.gov/solar/old_data/nsrdb/1991-2005/tmy3/

PNNL. (2007). *High-Performance Home Technologies: Solar Thermal & Photovoltaic Systems*. Volume 6: Building America Best Practices Series. Washington, D.C.: U.S. Department of Energy. NREL/TP-550-41085. PNNL-16362. www.nrel.gov/docs/fy07osti/41085.pdf

Rheem. (2012). Hybrid Electric Water Heater Efficiency Zones. Atlanta, GA. www.rheem.com/Products/tank_water_heaters/Hybrid_electric/efficiency

Rhodes, R. (2004). “Progress Report on Polymer Heat Exchanger Development.” deliverable to NREL from FAFCO, 9/30/2004. Available at jay.burch@nrel.gov.

Roberts, J. (2005). “Venting Overheat Protection in Solar Water Heaters.” In Proceedings 2005 American Solar Energy Society, ASES, Boulder, CO.

Ruud. (2012). Water Heaters. Atlanta, GA: Ruud Manufacturing Company. www.ruud.com/products/tank_water_heaters/hpwh/hpwhhomeowner/

Ruesch, F.; Brunold, S. (2008). “Ageing Performance of Collector Glazing Materials – Results from 20 Years of Outdoor Weathering.” In Proceedings Eurosun 2008.

SEIA. (2009). “U.S. Solar Industry Year in Review 2008.” Washington, DC.: Solar Energy Industries Association.

SEIA. (2011a). “U.S. Solar Market Insight Year in Review 2010.” Washington, D.C.: Solar Energy Industries Association.

SEIA. (2011b). “Majority of Americans See Benefits of Solar Water Heating, Feel Growth of Solar Water Heating Industry Creates Jobs and Deserves Government Support.” Washington, D.C.: Solar Energy Industries Association.

SEIA-GTM Research. (2011). “U.S. Solar Market Insight: 2nd Quarter 2010 – Executive Summary.” Washington, D.C.: Solar Energy Industries Association and Greentech Media Research.

SRCC. (2011). Annual Performance Ratings. Cocoa, FL: Solar Rating and Certification Corporation. www.solar-rating.org/ratings/index.html

Solrico. (2010). USA Market Statistics. www.solarthermalworld.org/node/1059

Sparn, B.; Hudon, K.; Christensen, D. (2011). *Laboratory Performance Evaluation of Residential Integrated Heat Pump Water Heaters*. Golden, CO: National Renewable Energy Laboratory. NREL/ TP-5500-52635. www.nrel.gov/docs/fy11osti/52635.pdf

- U.S. Bureau of Labor Statistics. (2011). Producer Price Index: Metals and Metal Products. Washington, D.C. <http://www.bls.gov/ro3/ppimetals.htm>
- U.S. Energy Information Administration, U.S. Department of Energy. (2009). Annual Energy Outlook 2009. Washington, DC DOE/EIA-0383(2009)
- USGS. (2009). Mineral Commodity Summaries 2009. Washington, D.C.: U.S. Geological Survey <http://minerals.usgs.gov/minerals/pubs/mcs/2009/mcs2009.pdf>
- Walker, A.; Roper, M. (1991). "Technical Inspection of 185 Active Solar Heating Systems in Colorado." In Proceedings of American Solar Energy Society, Cocoa Beach, FL., June 15–18, 1991.
- Weiss, W.; Mauthner, F. (2010). "Solar Heat Worldwide: Markets and Contribution to the Energy Supply 2008." Paris, France: IEA-SWH Programme. [www.iea-SWH.org/publications/downloads/publications/downloads/Solar_Heat_Worldwide-2010.pdf](http://www.iea-swh.org/publications/downloads/publications/downloads/Solar_Heat_Worldwide-2010.pdf)
- Weiss, W.; Mauthner, F. (2012). "Solar Heat Worldwide: Markets and Contribution to the Energy Supply 2010: 2012 Edition" Paris, France: IEA-SWH Programme.
- White House Blog. (2010). "Commitment to Lead: Solar on the White House." Posted by N. Sutley. www.whitehouse.gov/blog/2010/10/05/commitment-lead-solar-white-house
- Wilhelm, W.; Ripel, B. (1985). "Low-cost Thin-Material Solar Technology, The Key to a Viable Energy Alternative." U.S. India Workshop on Solar Energy R&D, CONF-850858-4/BNL36815/DE86 000025.

Appendix A. Solar Collector Technology

Solar collectors gather the sun's radiation and are a key element in all SWH systems. Basic types of solar collectors include flat-plate collectors, evacuated tube collectors, ICS systems, transpired collectors, and concentrating collectors. The collectors that gather both direct and diffuse solar radiation are described in the following paragraphs, followed by a short description of concentrating collectors, which gather direct radiation only.

Flat-Plate Collectors

Most solar collectors used in the United States are flat-plate collectors, which are generally designed to heat a fluid (water or air) at temperatures not exceeding 180°F. The two primary types are glazed (has a transparent cover) and unglazed flat-plate collectors.



Figure A-1. Glazed flat-plate collector.
Photo by Christopher Drake, NREL/PIX 09188

Liquid flat-plate collectors heat liquid (usually water or an antifreeze solution such as glycol) as it flows through tubes in or adjacent to a dark-colored absorber plate. The absorber plate is typically covered with a coating that absorbs solar energy while inhibiting heat loss from radiation. A glazed liquid flat-plate collector is covered with glass or translucent plastic to achieve higher temperatures (Figure A-1). An unglazed liquid flat-plate collector is not covered and is therefore often used for lower-temperature applications such as pool heating.

Air flat-plate collectors typically consist of a glazed, insulated metal box with a dark metal absorber plate. The sun heats the absorber plate, which heats the air in the collector. The air flows (by natural convection or fan) through the collector and across the absorber plate. Less heat is transferred between the air and the absorber than with a liquid flat-plate collector; however, air heating collectors can eliminate freezing or boiling associated with liquid systems.

Common applications for flat-plate collectors include residential and commercial water heating, pool heating, residential space heating, and industrial process heat. Efficiency varies with collector design and application temperature, but typical overall efficiency for a liquid flat-plate collector is 40%–50% in their normal operating range.

Evacuated Tube Collectors

Evacuated tube collectors can achieve temperatures of 170°–250°F. There are various types of evacuated tube collectors, and a typical collector is shown in Figure A-2. One common type is designed with parallel rows of twin glass tubes, with each inner glass tube containing a metal pipe attached to an absorber fin. The air between the two glass tubes is removed (or evacuated) to form a vacuum, which reduces conductive and convective heat loss. Common applications include residential and commercial water heating, space heating and cooling, and industrial process heat. Overall operating efficiencies of 30%–45% are typical.



Figure A–2. Evacuated tube collector. Photo by Alan Ford, NREL/PIX 09501

Integral Collector-Storage Systems

ICS systems preheat water before it goes to a conventional WH. These systems generally use one or more tanks or tubes that act as both the solar collector and storage within an insulated glazed box. ICS systems are passive in design, using building water pressure to maintain water flow. ICS systems are primarily used for residential and commercial water heating in warm climates.

Transpired Air Collectors

Transpired air collector systems consist of dark, perforated metal plates installed on the south face of a building, with an air space between the building wall and the metal plate. An added fan or the existing ventilation system draws air through the perforations and into the air space between the collector and the building. Most transpired air collectors do not require glazing and can warm the air by as much as 40°F. Common applications for transpired air collectors include commercial air heating and ventilation systems.

Hybrid Photovoltaic/Thermal Collectors

Combined PV/thermal collectors incorporate electricity generation and thermal energy collection in the same equipment. Collecting both thermal and electric energy enables more efficient use of roof space and can increase total energy yield from a system with potentially lower costs than separate standalone SWH and PV systems. PV/thermal systems can use either liquids or air as their heat transfer medium. Common applications include residential water heating, space heating, and pool heating.

Concentrating Collectors

Concentrating collectors use mirrors or lenses over a large area to focus the sun's rays onto a smaller absorber (called a receiver). The major types of concentrating collectors are parabolic trough and linear Fresnel. Concentrating systems are most practical in areas with high direct solar insolation. Common applications include district water heating systems, commercial space cooling systems, water purification, and industrial process heat.

Appendix B. Calculating Source Energy Savings

The annual energy savings of HPWH and SWH technologies depend on geographical location. The performance of an SWH system strongly depends on solar radiation and the local climate. Hence, the SRCC lists the estimated annual performance of the residential solar water heating systems it has certified for various locations throughout the United States (SRCC 2011). Similarly, the performance of an HPWH depends on the incoming water temperature and the installation location's surrounding air temperature. Rheem Manufacturing Company publishes a U.S. map of efficiency zones on its HPWH website, as shown in Figure B-1 (Rheem 2012).

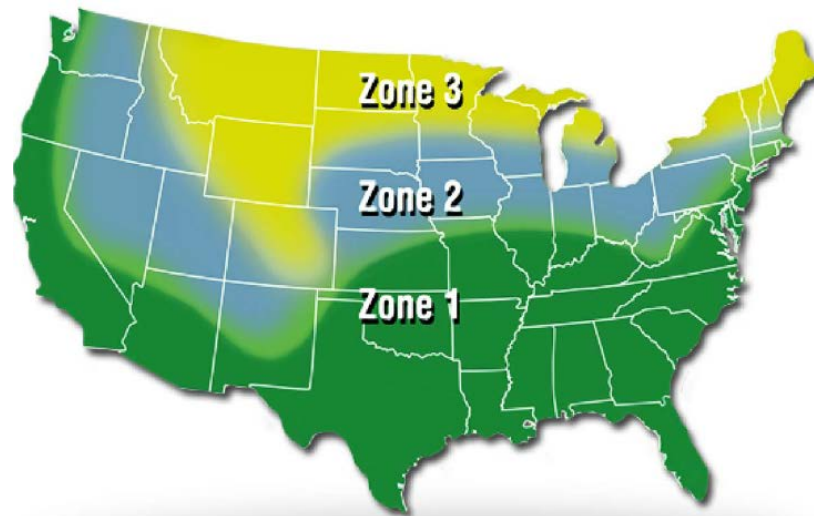

Figure B-1. Efficiency zones—Rheem hybrid electric HPWH technology (Rheem, used by Permission) www.rheem.com/Products/tank_water_heaters/Hybrid_electric/efficiency

Ruud, has the same map on its HPWH website (Ruud 2012), describing it as:

“The map indicates, on the average, the most favorable locations for heat pump water heaters. Annual weather patterns and other factors will determine your overall energy efficiency.”

1. **Zone 1:** Heat pump will be used most of the year (90-100%)
2. **Zone 2:** Combination heat pump (60%) and electric heating elements (40%)
3. **Zone 3:** Combination heat pump (50%) and electric heating elements (50%)”

The annual source energy savings for locations within these three zones can be calculated and used to compare the performance of HPWH and SWH technologies. To accurately calculate energy use of HPWH technology, a TRNSYS model was developed at NREL based on performance data collected during a laboratory experiment (Hudon et al. 2012). A TRNSYS model was also used for a typical SWH system and compared to the performance of the HPWH for the same weather conditions, inlet water temperature, house model, hot water load, and set point temperature. Sensitivities to set point temperature and

hot water load were also explored. In the end, all comparisons are made using source energy so the best water heating method can be determined for a given location. The source energy savings for each technology is given in kilowatt-hours so that comparisons between HPWHs and SWHs can easily be made. For SWHs, source energy is typically reported in therms. The “equivalent kilowatt-hours” are calculated using the following conversion: 1 therm = 29.3 kWh.

Heat Pump Water Heater Annual Energy Savings

An HPWH model was created in TRNSYS based on data collected during laboratory testing of five residential integrated HPWH units (Sparn et al. 2011). The HPWH used to create this model has an EF rating of 2.35. The EF describes the efficiency of the WH and takes into account recovery after draws and standby losses. It is a standard used to compare the efficiencies of various WHs and is defined in the DOE WH test procedure (DOE 1998). This TRNSYS model uses a performance map of the heat pump as input and models the physics of the storage tank as well as the control logic of the unit. The model can predict the energy consumption measured during a draw profile test within 2% of the actual energy use (Hudon et al. 2012).

The model was run through an annual simulation at 930 U.S. locations to determine the energy savings associated with replacing a natural gas or electric resistance WH with an HPWH. The house used in the simulation is based on a typical new construction home, having three bedrooms and two bathrooms. Many of the guidelines from the Building America program are assumed in this house model (Hendron and Engebrecht 2010). For all the simulated sites, the “mixed” draw volume is held constant at 69.2 gal. Mixed volumes are assumed to deliver water at 105°F. This means that the hot water load varies depending on the mains water temperature at a given location. The set point temperature for the water heaters is 120°F.

For these comparisons, the HPWH is assumed to be installed within the conditioned space of the residence. The source energy savings takes into account the effect of the WH on the space conditioning equipment in the home. In particular, the stand-by losses associated with the storage tanks are considered. For the case when a HPWH or SWH is replacing an electric resistance WH, an air-source heat pump is assumed to provide the heating and cooling to the house. If a natural gas WH is being replaced, the house is assumed to have a furnace/air-conditioning system to provide the heating and cooling. The nominal auxiliary tank size was 50 gal for all comparisons, and the EF was assumed to be 0.6 for a gas auxiliary tank and 0.9 for an electric resistance auxiliary tank. Typical loss coefficients were used to determine the standby losses associated with the tanks.

The results of the 930 simulations are shown in Figure B–2. This map shows the source energy savings associated with using a HPWH compared to an electric resistance WH. This map shows that in every region of the continental United States, some level of annual source energy savings can be achieved by replacing an electric resistance WH with an HPWH.

Source Energy Savings of a HPWH vs an Electric WH in Conditioned Space, ASHP Case

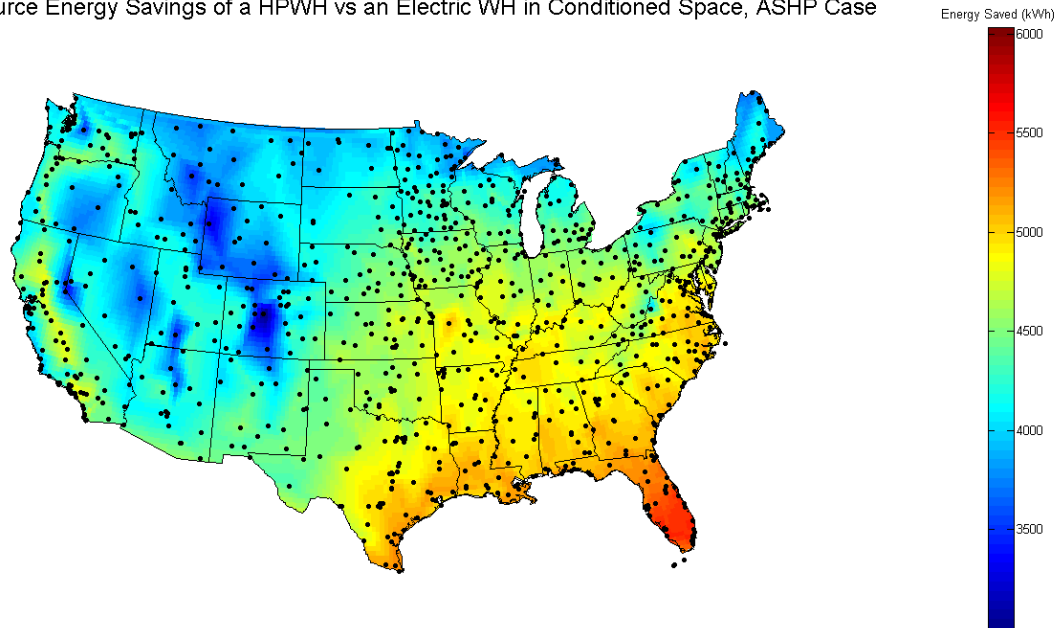

Figure B-2. Annual Energy Savings: HPWH versus electric resistance WH

The results for four locations, which correspond to the three HPWH performance zones, are shown in Tables B-1 and B-2. The site-to-source ratios used for natural gas and electric resistance were 1.092 and 3.365, respectively (Hendron and Engebrecht 2010). Two locations were selected for Zone 1. Houston is located in a hot/humid climate; Atlanta in a mild/humid climate. Chicago and Helena are in cold climates (DOE 2011g).

These results show that a HPWH will save significant annual source energy over an electric resistance WH. The most energy savings will be seen in the warmer climates represented by Zone 1 (Figure B-1).

Table B-1. Site Energy Savings for HPWH (in Conditioned Space) versus Electric Resistance WH

Location	Annual Energy Use for Electric WH (kWh)	Annual Energy Use for HPWH (kWh)	Annual Energy Savings (kWh)	Percent Site Energy Savings – HPWH Versus Electric
Zone 1 – Houston, TX	2394	867	1527	63.8%
Zone 1 – Atlanta, GA	2802	1353	1449	51.7%
Zone 2 – Chicago, IL	3532	2163	1369	38.7%
Zone 3 – Helena, MT	3837	2893	1145	29.8%

Table B–2. Source Energy Savings for HPWH (in Conditioned Space) versus Electric Resistance WH

Location	Annual Energy Use for Electric WH (kWh)	Annual Energy Use for HPWH (kWh)	Annual Energy Savings (kWh)	Percent Source Energy Savings – HPWH Versus Electric
Zone 1 – Houston, TX	8055	2916	5139	63.8%
Zone 1 – Atlanta, GA	9428	4553	4875	51.7%
Zone 2 – Chicago, IL	11885	7280	4605	38.7%
Zone 3 – Helena, MT	12912	9061	3852	29.8%

Figure B–3 shows the annual source energy savings associated with using a HPWH compared to a natural gas WH. The scale on this map is different from that used for the comparison to electric resistance WHs. The yellow region on this map represents zero energy savings. Locations north of the yellow region will experience negative annual source energy savings when replacing a natural gas WH with a HPWH. The results for four locations are shown in Tables B–3 and B–4.

Source Energy Savings of a HPWH vs a Gas WH in Conditioned Space, Furnace/AC Case

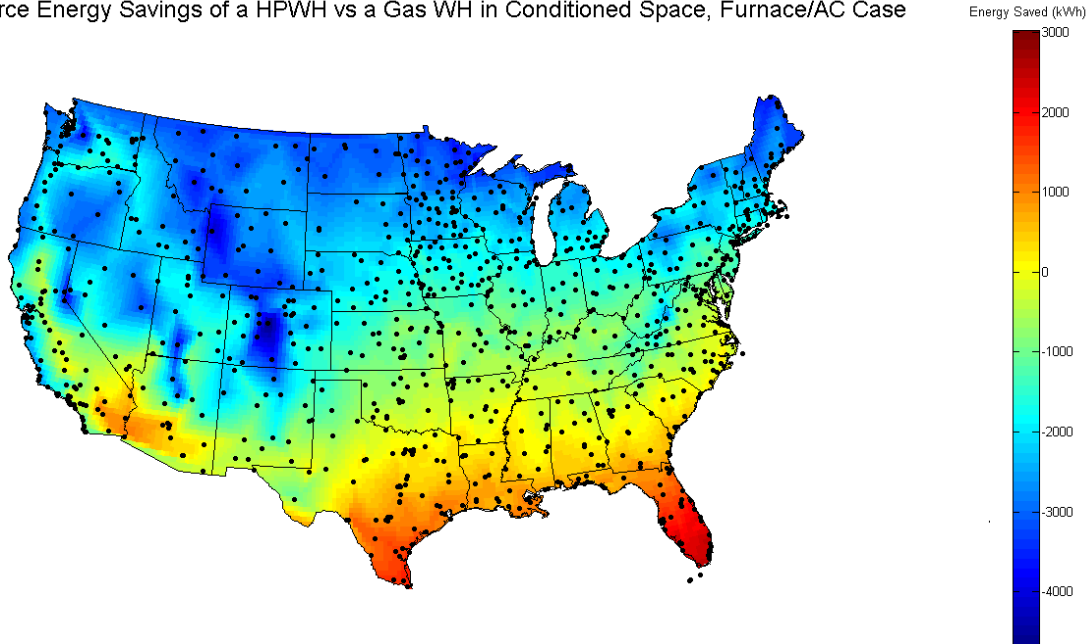

Figure B–3. Annual Energy Savings: HPWH versus natural gas WH

Table B–3. Site Energy Savings for HPWH (in Conditioned Space) versus Natural Gas WH

Location	Annual Energy Use for Gas WH (kWh)	Annual Energy Use for HPWH (kWh)	Annual Energy Savings (kWh)	Percent Site Energy Savings – HPWH Versus Gas
Zone 1 – Houston, TX	3786	1466	2320	61.3%
Zone 1 – Atlanta, GA	4304	2247	2056	47.8%
Zone 2 – Chicago, IL	5222	3310	1911	36.6%
Zone 3 – Helena, MT	5610	3956	1654	29.5%

Table B–4. Source Energy Savings for HPWH (in Conditioned Space) versus Natural Gas WH

Location	Annual Energy Use for Gas WH (kWh)	Annual Energy Use for HPWH (kWh)	Annual Energy Savings (kWh)	Percent Source Energy Savings – HPWH Versus Gas
Zone 1 – Houston, TX	4127	3107	1027	24.9%
Zone 1 – Atlanta, GA	4700	4823	–123	–2.6%
Zone 2 – Chicago, IL	5702	7314	–1612	–28.3%
Zone 3 – Helena, MT	6126	9086	–2961	–48.3%

These results show that an HPWH will not save significant source energy when replacing a natural gas WH in most regions of the continental United States. In fact, these savings are negative in most locations. This is because the site-to-source ratio for electricity is significantly higher than gas, which offsets the site energy savings associated with the technology. Based on these results, HPWH technology will not save source energy when replacing a natural gas WH, unless the technology is placed in a hot climate such as Houston.

Figure B–4 emphasizes the regions where replacing a natural gas WH with an HPWH can result in positive source energy savings. The red dots represent locations with positive annual source energy savings and the blue dots represent negative source energy savings.

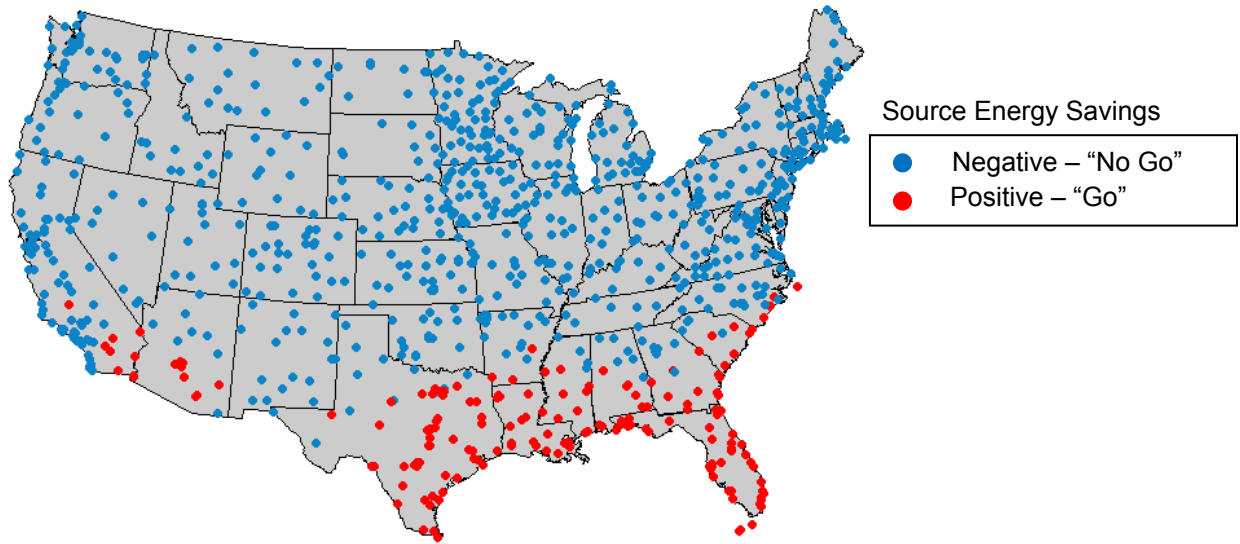

Figure B-4. “Go/no go” annual source energy savings for an HPWH versus gas WH in conditioned space, furnace/air-conditioning case

Although this model is accurate compared to the data taken in the laboratory, several assumptions should be noted:

- This model is based on data from ONE unit tested in the laboratory. The five HPWHs tested were designed by different manufacturers and therefore have different component sizes and control logic. The modeled unit was chosen because it is the most readily available and has undergone significant R&D.
- The performance map used to determine the energy use of the heat pump is based on the test points collected during testing. Interpolation and extrapolation are used when the inlet air or water conditions are outside the range of conditions tested. This could introduce some uncertainty in the results.
- HPWHs sometimes deliver water at a lower temperature than conventional gas or electric WHs because of their slower recovery rate. When the HPWH could not meet the load, a correction was applied as prescribed in the DOE WH test procedure (DOE 1998), used for directly comparing WHs.

Solar Water Heating Annual Energy Savings

An SWH model was created in TRNSYS using components available in the simulation program. This model represents a “typical” SWH made by Alternate Energy Technologies. It is an indirect forced circulation system that comprises two glazed flat-plate collectors with a selective surface coating and a gross collector area of 64 ft². When the collector is paired with a natural gas auxiliary tank, a two-tank system with an 80-gal solar storage tank and a 50-gal natural gas auxiliary tank is used. When the collector is paired with an electric resistance auxiliary tank, a single tank system with an 80-gal auxiliary tank is used. A schematic of the SWH system was taken from the SRCC website for the solar system with the two-tank gas auxiliary (see Figure B-5).

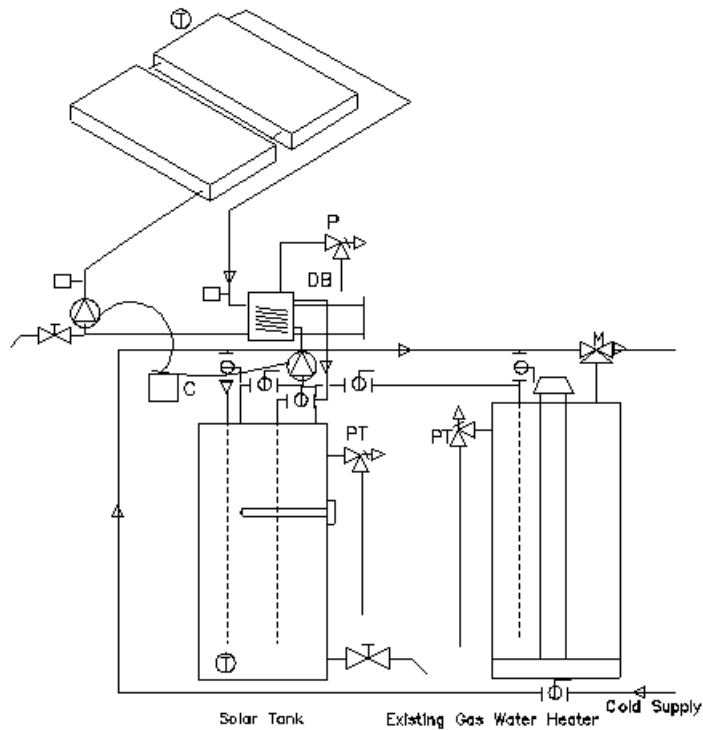

Figure B–5. Schematic for SRCC TRNSYS model of a “typical” SWH system with a gas auxiliary WH (OG-300 System Reference: 2010016B) (SRCC, used by permission)

In the United States, four collector sizes are common for SWH systems: 32 ft², 40 ft², 64 ft², and 80 ft² (Cassard et al. 2011b). Most systems have a collector area of either 40 ft² or 64 ft² (see Figure B–6), and most states show diminishing returns when larger collector areas are used. For cold climates, such as New York City and Colorado, larger systems do not show significant diminishing returns for larger collector areas. Because a likely collector size in cold climates is 64 ft², this was the collector size chosen for this comparison.

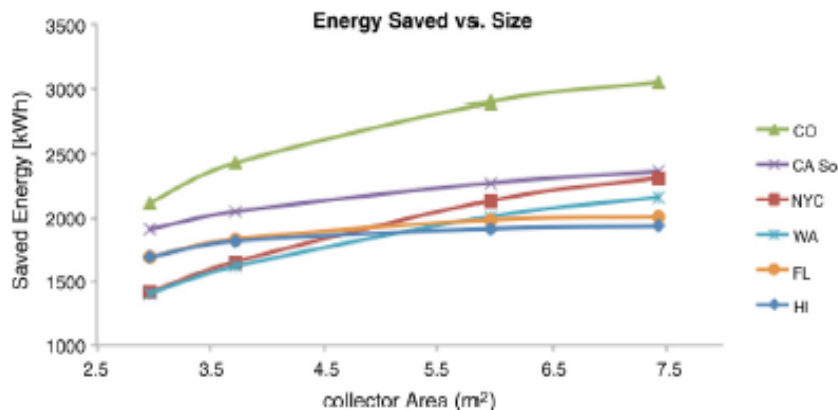

Figure B–6. Curve of energy saved versus collector area for four discrete system sizes and select states

The SWH model was run through an annual simulation for Houston, Atlanta, Chicago, and Helena to determine the energy savings associated with replacing a natural gas or electric resistance WH with an SWH. In the next section, the source energy savings will be compared to the source energy savings associated with HPWH technology. The house and hot water load used in the simulation are the same as in the HPWH simulation. The effect of tank losses on the space conditioning equipment in the home is taken into account; the energy used by the electrical pump to circulate the water is also considered.

The results of the SWH simulations are shown in Tables B-5 through B-8. Tables B-5 and B-6 show the site and source energy savings associated with using a SWH compared to an electric resistance WH; Tables B-7 and B-8 show the site and source energy savings associated with using an SWH compared to a natural gas WH.

Table B-5. Site Energy Savings for Solar versus Electric Resistance WH

Location	Annual Energy Use for Electric WH (kWh)	Annual Energy Use for SWH With Electric Auxiliary (kWh)	Annual Energy Savings (kWh)	Percent Site Energy Savings – SWH Versus Electric
Zone 1 – Houston, TX	2394	924	1469	61.4%
Zone 1 – Atlanta, GA	2802	1199	1603	57.2%
Zone 2 – Chicago, IL	3532	2122	1410	39.9%
Zone 3 – Helena, MT	3837	2275	1562	40.7%

Table B-6. Source Energy Savings for Solar versus Electric Resistance WH

Location	Annual Energy Use for Electric WH (kWh)	Annual Energy Use for SWH With Electric Auxiliary (kWh)	Annual Energy Savings (kWh)	Percent Source Energy Savings – SWH Versus Electric
Zone 1 – Houston, TX	8055	3111	4944	61.4%
Zone 1 – Atlanta, GA	9428	4033	5396	57.2%
Zone 2 – Chicago, IL	11885	7142	4743	39.9%
Zone 3 – Helena, MT	12912	7656	5256	40.7%

Table B-7. Site Energy Savings for Solar versus Natural Gas Water Heating

Location	Annual Energy Use for Gas WH (kWh)	Annual Energy Use for SWH With Gas Auxiliary (kWh)	Annual Energy Savings (kWh)	Percent Site Energy Savings – SWH Versus Gas
Zone 1 – Houston, TX	3786	1762	2024	53.5%
Zone 1 – Atlanta, GA	4304	1948	2356	54.7%
Zone 2 – Chicago, IL	5222	3033	2189	41.9%
Zone 3 – Helena, MT	5610	3044	2566	45.7%

Table B–8. Source Energy Savings for Solar versus Natural Gas Water Heating

Location	Annual Energy Use for Gas WH (kWh)	Annual Energy Use for SWH w/ Gas Auxiliary (kWh)	Annual Energy Savings (kWh)	Percent Source Energy Savings – SWH Versus Gas
Zone 1 – Houston, TX	4134	2532	1602	38.8%
Zone 1 – Atlanta, GA	4700	2628	2072	44.1%
Zone 2 – Chicago, IL	5702	3707	1995	35.0%
Zone 3 – Helena, MT	6126	3631	2495	40.7%

The results show that adding an SWH to either an electric resistance or natural gas WH results in positive annual source energy savings regardless of location. This assumes the system is designed properly to meet the hot water load.

Heat Pump Water Heater Versus Solar Water Heater Comparisons

Many parameters in the TRNSYS models used for the HPWH and SWH simulations were held constant so the annual source energy savings could be compared for the two technologies. The parameters that are the same for both simulations are summarized in Table B–9.

Table B–9. TRNSYS Parameters Held Constant for HWP and SWH Simulations

TRNSYS Input Parameters	Input Value
Weather data	TMY3 files (NREL 2008)
Nominal auxiliary tank size*	50 gal
Set point temperature	120°F
Typical house	3 bedroom, 2 bath
Hot water draw volume	69.2 gal (mixed)

*All cases except for the SWH with the 80 gallon electric resistance auxiliary tank

Figure B–7 shows the annual source energy savings for HPWHs and SWHs compared to electric resistance WHs. These results show that for homes with electric resistance WHs, either an SWH system or an HPWH can save a significant portion of the energy required to meet the hot water load. This figure shows that both technologies are energy-saving replacement options for electric resistance WHs.

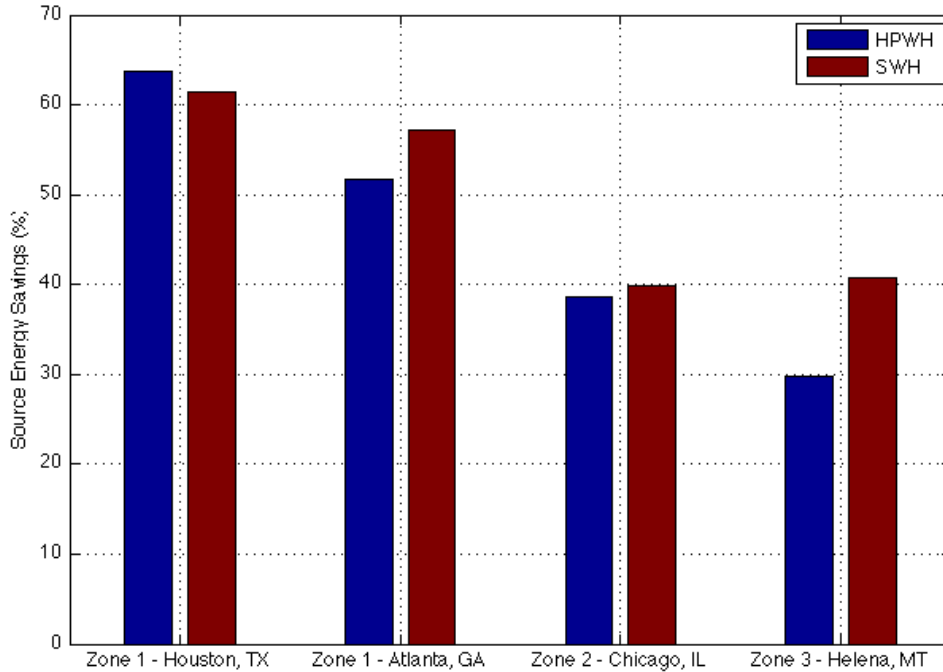

Figure B-7. Annual source energy savings for HPWH and SWH technologies versus electric resistance WH

Figure B-8 shows the annual source energy savings for HPWHs and SWHs compared to natural gas WHs. This graph shows that for homes with natural gas WHs, an SWH system will result in significant annual source energy savings. This figure also shows that in most regions, HPWHs will not save source energy when replacing a natural gas WH (see Figure B-4).

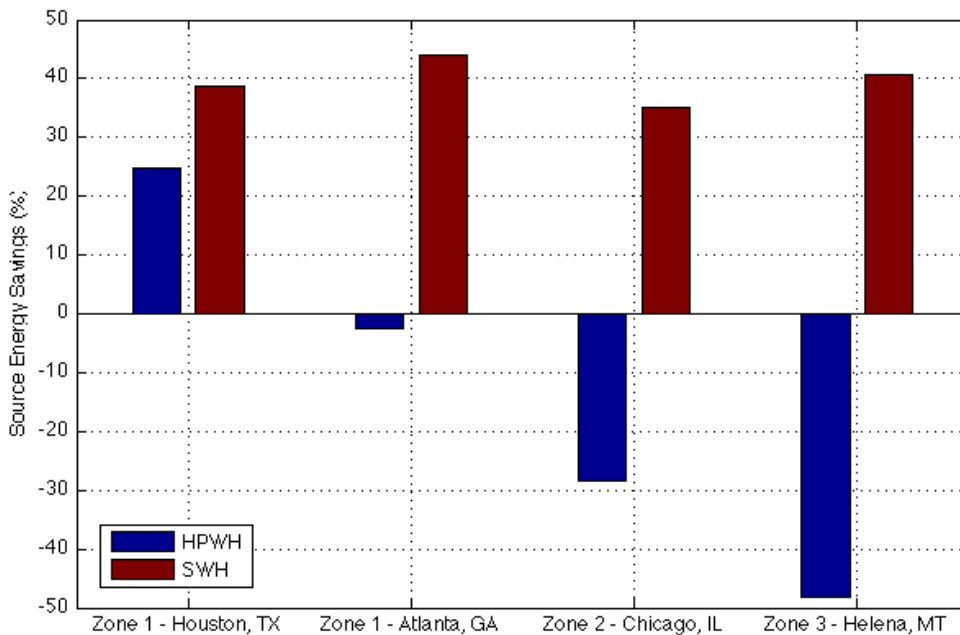

Figure B-8. Annual source energy savings for HPWH and SWH technologies versus natural gas WH

Sensitivity Studies

In addition to the baseline cases run for this analysis, sensitivity studies were performed to determine how the source energy comparisons are affected by the hot water set point temperature and the daily hot water load. Tables B–10 and B–11 compare the source energy savings for HPWH and SWH technologies to electric resistance WHs at a set point temperature of 130°F. A comparison to the baseline case, which uses a set point temperature of 120°F, is shown graphically in Figure B–9.

Table B–10. Source Energy Savings for HPWH versus Electric Resistance WH for a Set Point Temperature of 130°F

Location	Annual Energy Use for Electric WH (kWh)	Annual Energy Use for HPWH With Electric Auxiliary (kWh)	Annual Energy Savings (kWh)	Percent Source Energy Savings – HPWH Versus Electric
Zone 1 – Houston, TX	9456	3589	5867	62.0%
Zone 1 – Atlanta, GA	10825	5273	5552	51.3%
Zone 2 – Chicago, IL	13275	8123	5152	38.8%
Zone 3 – Helena, MT	14297	9938	4360	30.5%

Table B–11. Source Energy Savings for Solar versus Electric Resistance WH for a Set Point Temperature of 130°F

Location	Annual Energy Use for Electric WH (kWh)	Annual Energy Use for SWH w/ Electric Auxiliary (kWh)	Annual Energy Savings (kWh)	Percent Source Energy Savings – SWH Versus Electric
Zone 1 – Houston, TX	9456	4239	5217	55.2%
Zone 1 – Atlanta, GA	10825	5234	5591	51.7%
Zone 2 – Chicago, IL	13275	8397	4878	36.7%
Zone 3 – Helena, MT	14297	8934	5363	37.5%

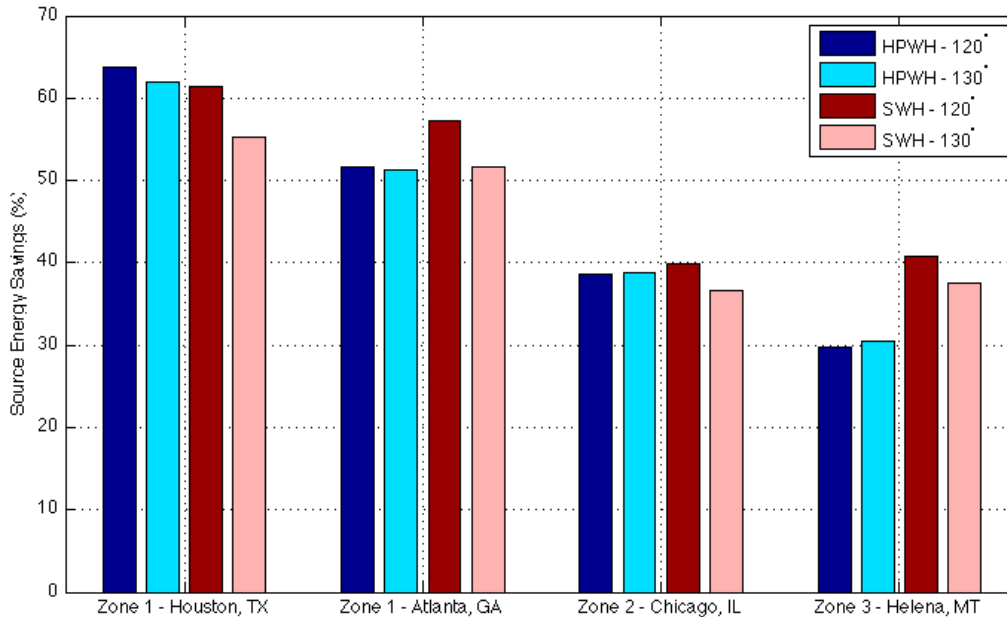

Figure B-9. Annual source energy savings for HPWH and SWH technologies versus electric resistance water heating for set point temperatures of 120°F and 130°F

These results show that the energy savings associated with HPWH technologies do not strongly depend on the set point temperature used by the homeowner. The SWH results show a small dependence on set point temperature. As the set point temperature increases, the energy savings decreases for SWHs. The change from a set point of 120°F to 130°F results in a change in annual source energy of 2%–5%, depending on location.

Tables B-12 and B-13 compare the source energy savings for HPWH and SWH technologies to natural gas WHs at a set point temperature of 130°F. A comparison to the baseline case, which uses a set point temperature of 120°F, is shown graphically in Figure B-10.

Table B-12. Source Energy Savings for HPWH versus Natural Gas WH for a Set Point Temperature of 130°F

Location	Annual Energy Use for Gas WH (kWh)	Annual Energy Use for HPWH With Gas Auxiliary (kWh)	Annual Energy Savings (kWh)	Percent Source Energy Savings – HPWH Versus Gas
Zone 1 – Houston, TX	4903	3736	1166	23.8%
Zone 1 – Atlanta, GA	5468	5567	–99	–1.8%
Zone 2 – Chicago, IL	6463	8191	–1728	–26.7%
Zone 3 – Helena, MT	6888	10047	–3159	–45.9%

Table B–13. Source Energy Savings for Solar versus Natural Gas WH for a Set Point Temperature of 130°F

Location	Annual Energy Use for Gas WH (kWh)	Annual Energy Use for SWH w/ Gas Auxiliary (kWh)	Annual Energy Savings (kWh)	Percent Source Energy Savings – SWH Versus Gas
Zone 1 – Houston, TX	4903	3315	1587	32.4%
Zone 1 – Atlanta, GA	5468	3390	2078	38.0%
Zone 2 – Chicago, IL	6463	4457	2006	31.0%
Zone 3 – Helena, MT	6888	4381	2508	36.4%

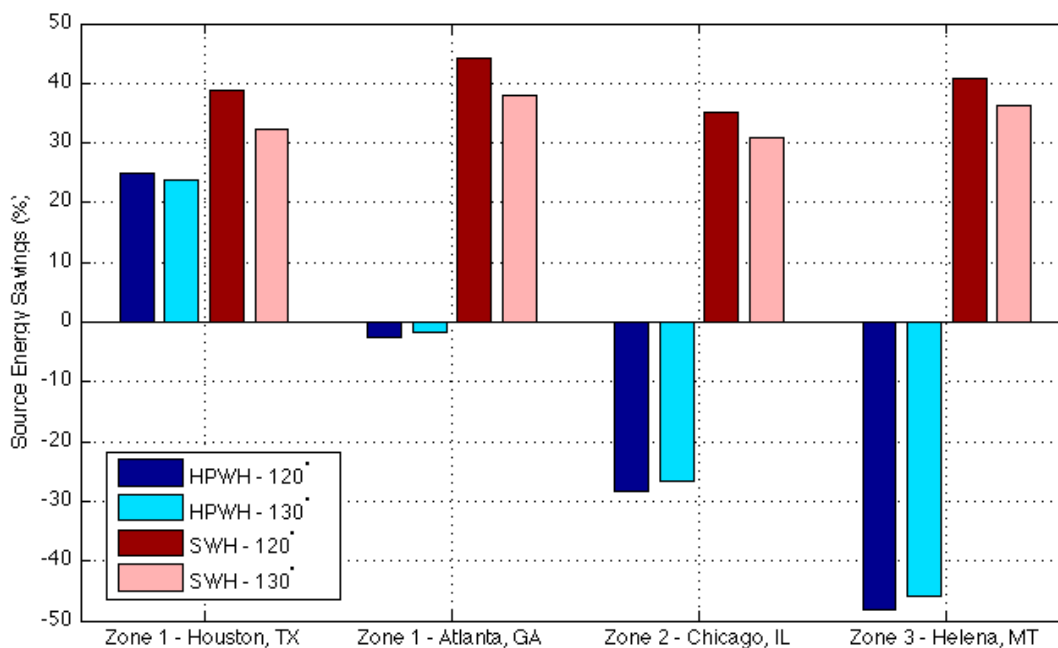

Figure B–10. Source energy savings for solar versus natural gas WH for a set point temperature of 130°F

These results show a small dependence on set-point temperature, similar to the results shown for the comparison to the electric resistance WHs. The change from a set-point of 120°F to 130°F results in a change in annual source energy of 2%–7%.

Tables B–14 through B–17 compare the source energy savings for HPWH and SWH technologies to electric resistance WHs for low- and high-use households. The hot water load for the low-use household corresponds to the use of a typical one-bedroom house, which will use approximately 45 gal of mixed water volume per day. For a high-use household, a typical five-bedroom household was used. This corresponds to a mixed water volume of 95.5 gal/day. The house model was not modified for the hot water load study. Only the volume of mixed water drawn was varied. These studies assumed a set point temperature of 120°F. A comparison to the baseline case, which uses a mixed draw volume of 69.2 gal/day, is shown graphically in Figure B–11.

Table B–14. Source Energy Savings for HPWH versus Electric Resistance WH for Low-Use Home

Location	Annual Energy Use for Electric WH (kWh)	Annual Energy Use for HPWH With Electric Auxiliary (kWh)	Annual Energy Savings (kWh)	Percent Source Energy Savings – HPWH Versus Electric
Zone 1 – Houston, TX	5689	2020	3669	64.5%
Zone 1 – Atlanta, GA	6589	3063	3526	53.5%
Zone 2 – Chicago, IL	8194	4761	3433	41.9%
Zone 3 – Helena, MT	8867	5937	2929	33.0%

Table B–15. Source Energy Savings for Solar versus Electric Resistance WH for Low-Use Home

Location	Annual Energy Use for Electric WH (kWh)	Annual Energy Use for SWH With Electric Auxiliary (kWh)	Annual Energy Savings (kWh)	Percent Source Energy Savings – SWH Versus Electric
Zone 1 – Houston, TX	5689	1696	3993	70.2%
Zone 1 – Atlanta, GA	6589	2171	4418	67.1%
Zone 2 – Chicago, IL	8194	4145	4049	49.4%
Zone 3 – Helena, MT	8867	4405	4461	50.3%

Table B–16. Source Energy Savings for HPWH versus Electric Resistance WH for High-Use Home

Location	Annual Energy Use for Electric WH (kWh)	Annual Energy Use for HPWH With Electric Auxiliary (kWh)	Annual Energy Savings (kWh)	Percent Source Energy Savings – HPWH Versus Electric
Zone 1 – Houston, TX	10334	3949	6385	61.8%
Zone 1 – Atlanta, GA	12190	6132	6057	49.7%
Zone 2 – Chicago, IL	15533	9980	5553	35.7%
Zone 3 – Helena, MT	16970	12388	4582	27.0%

Table B-17. Source Energy Savings for Solar versus Electric Resistance WH for High-Use Home

Location	Annual Energy Use for Electric WH (kWh)	Annual Energy Use for SWH With Electric Auxiliary (kWh)	Annual Energy Savings (kWh)	Percent Source Energy Savings – SWH Versus Electric
Zone 1 – Houston, TX	10334	4791	5543	53.6%
Zone 1 – Atlanta, GA	12190	6199	5991	49.1%
Zone 2 – Chicago, IL	15533	10407	5126	33.0%
Zone 3 – Helena, MT	16970	11282	5688	33.5%

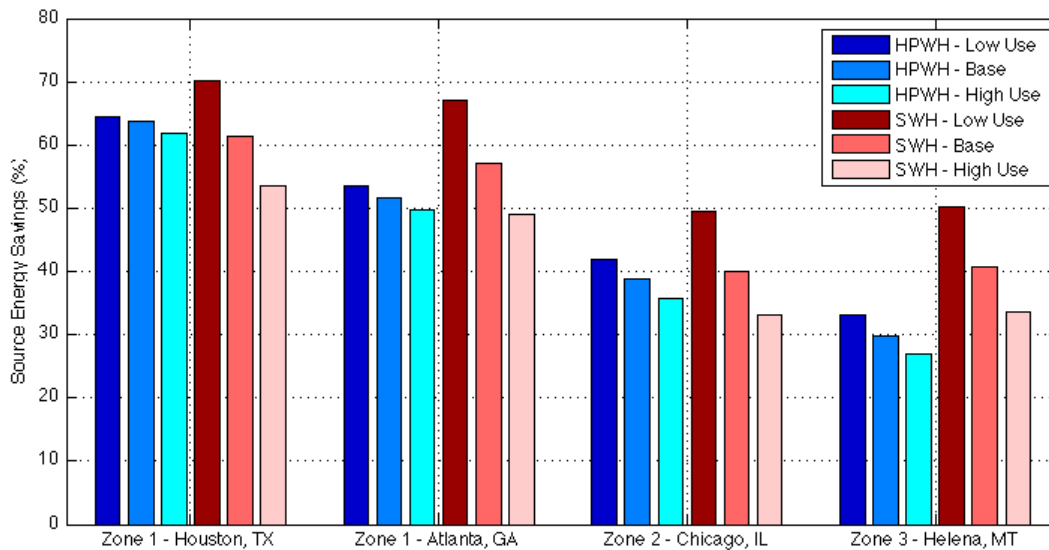

Figure B-11. Annual source energy savings for HPWH and SWH technologies versus electric resistance WH for low and high hot water use

These results show that the energy savings associated with HPWH and SWH technologies depend on the daily volume of hot water drawn. For HPWHs, the energy savings varied from the base case by 1%–3%. The SWHs, the effect was larger, 6%–10% from the base case.

Tables B-18 through B-21 compare the source energy savings for HPWH and SWH technologies to natural gas WHs for low- and high-use households. A comparison to the baseline case, which uses a mixed draw volume of 69.2 gal/day, is shown graphically in Figure B-12.

Table B–18. Source Energy Savings for HPWH versus Natural Gas WH for Low-Use Home

Location	Annual Energy Use for Gas WH (kWh)	Annual Energy Use for HPWH With Gas Auxiliary (kWh)	Annual Energy Savings (kWh)	Percent Source Energy Savings – HPWH Versus Gas
Zone 1 – Houston, TX	3212	2118	1094	34.1%
Zone 1 – Atlanta, GA	3593	3275	318	8.9%
Zone 2 – Chicago, IL	4259	4843	–584	–13.7%
Zone 3 – Helena, MT	4544	6007	–1463	–32.2%

Table B–19. Source Energy Savings for Solar versus Natural Gas WH for Low-Use Home

Location	Annual Energy Use for Gas WH (kWh)	Annual Energy Use for SWH With Gas Auxiliary (kWh)	Annual Energy Savings (kWh)	Percent Source Energy Savings – SWH Versus Gas
Zone 1 – Houston, TX	3212	2045	1168	36.3%
Zone 1 – Atlanta, GA	3593	1969	1624	45.2%
Zone 2 – Chicago, IL	4259	2621	1638	38.4%
Zone 3 – Helena, MT	4544	2436	2108	46.4%

Table B–20. Source Energy Savings for HPWH versus Natural Gas WH for High-Use Home

Location	Annual Energy Use for Gas WH (kWh)	Annual Energy Use for HPWH With Gas Auxiliary (kWh)	Annual Energy Savings (kWh)	Percent Source Energy Savings – HPWH Versus Gas
Zone 1 – Houston, TX	5031	4183	848	16.9%
Zone 1 – Atlanta, GA	5791	6460	–669	–11.5%
Zone 2 – Chicago, IL	7138	9946	–2808	–39.3%
Zone 3 – Helena, MT	7722	12346	–4624	–59.9%

Table B–21 Source Energy Savings for Solar Versus Natural Gas WH for High-Use Home

Location	Annual Energy Use for Gas WH (kWh)	Annual Energy Use for SWH With Gas Auxiliary (kWh)	Annual Energy Savings (kWh)	Percent Source Energy Savings – SWH Versus Gas
Zone 1 – Houston, TX	5031	3143	1888	37.5%
Zone 1 – Atlanta, GA	5791	3410	2381	41.1%
Zone 2 – Chicago, IL	7138	4869	2269	31.8%
Zone 3 – Helena, MT	7722	4944	2778	36.0%

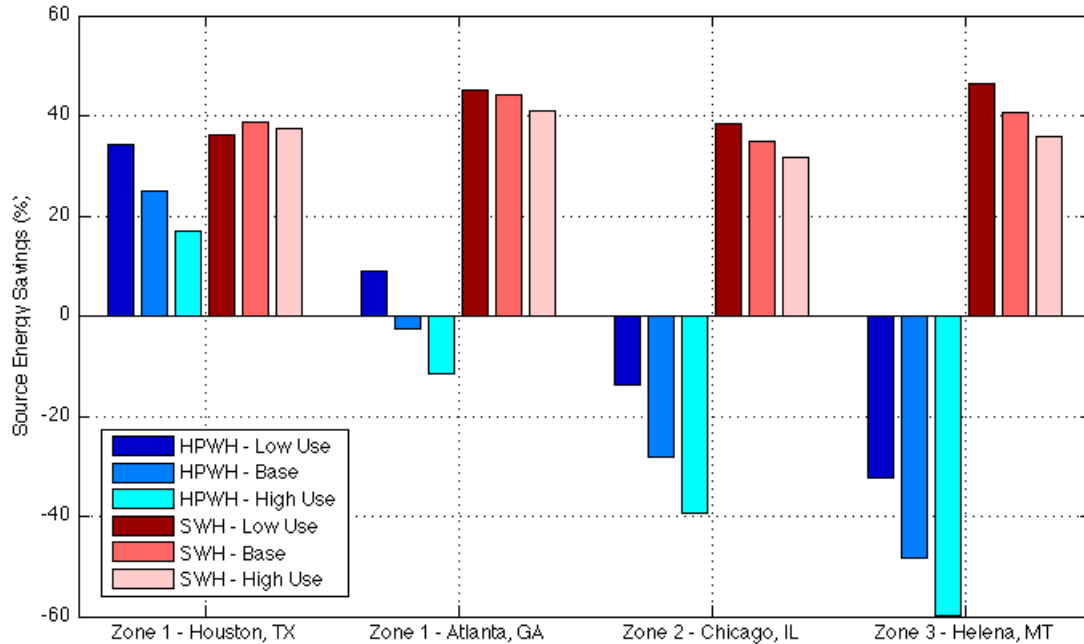

Figure B-12. Annual source energy savings for HPWH and SWH technologies versus natural gas WH for low and high hot water use

As with the comparison to the electric resistance WH, these results show that the energy savings associated with HPWH and SWH technologies depend on the daily volume of hot water drawn. For HPWHs, the energy savings varied from the base case by 7%–12%. For SWHs, the annual source energy savings varied from the base case by 1%–6%.

Appendix C. Solar Pool Heating Technology and Market Status

Residential solar pool heating systems use the existing pool-filtration system to pump water from the pool to the solar collector array. The sun heats the water as it flows through the array and the heated water is returned directly back to the pool. Solar pool heating collectors typically operate at a slightly warmer temperature than the surrounding air and normally are unglazed. These low-temperature collectors are often made from polymers, as shown in Figure C-1.



Figure C-1. Photo of polymer solar pool collectors. Photo from Aquatherm Industries, NREL/PIX 07175

Solar pool heating applications represent the largest producer of renewable solar energy in the United States today, and are most often used for individual residences. However, hotels, schools, municipal governments, and other commercial customers are starting to adopt this technology.

Figure C-2 displays the amount of collector area that was installed for solar pool heating and SWH in 2008 (EIA 2010a). Solar space heating and combined space and water heating together accounted for approximately 300,000 ft² of collector area in 2008.

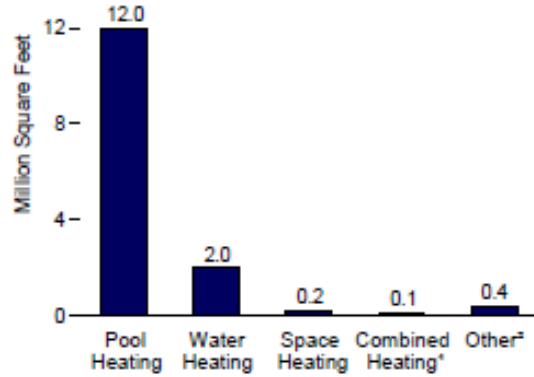

Figure C-2. U.S. solar thermal collector shipments by end use, 2008

Solar pool heating systems for outdoor pools generally use unglazed flat-plate solar collectors equivalent in area to 50%–100% of the surface area of the pool. The larger the system, the longer the pool season can last. The installed cost of a residential solar pool heating system is \$2,000–10,000 (or \$7–\$12/ft²), depending on the system type and size. The payback period is typically 1.5–7 years, depending on the cost of the competing system and/or the energy source. Solar pool heaters require minimal maintenance and have a life expectancy of 10–20 years.

Figure C-3 illustrates the number of solar pool heating systems installed in the United States between 1974 and 2010 (SEIA-GTM 2011). Solar pool heating shipments began to drop off in 2007 commensurate with the economic slowdown, while SWH equipment shipments began to increase because the federal 30% investment tax credit was enacted in 2006. Most of the solar pool heating systems were installed in Florida, California, and Arizona, where heating a pool extends the swimming season in the spring, fall, and winter.

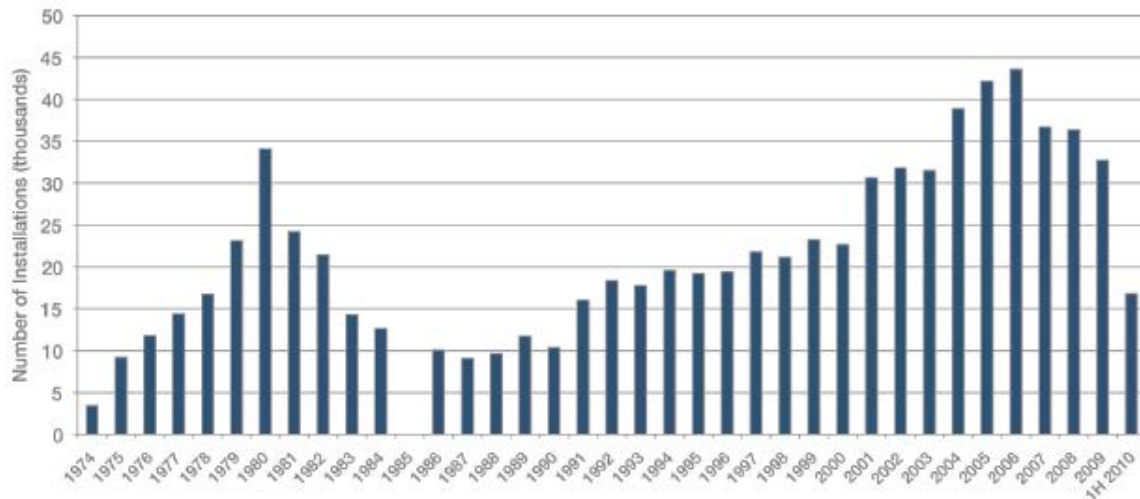

Figure C-3. U.S. solar pool heating system installations, 1974—first half 2010. (SEIA, used by permission)

There are approximately 4.8 million swimming pools in the United States and approximately 800,000 solar pool heating systems. This corresponds to about a 16% penetration rate—the highest penetration rate of any solar technology in the United States.

Figure C–4 shows the breakdown of residential and nonresidential solar pool heating installations from 2000 to 2010 (SEIA-GTM 2011).

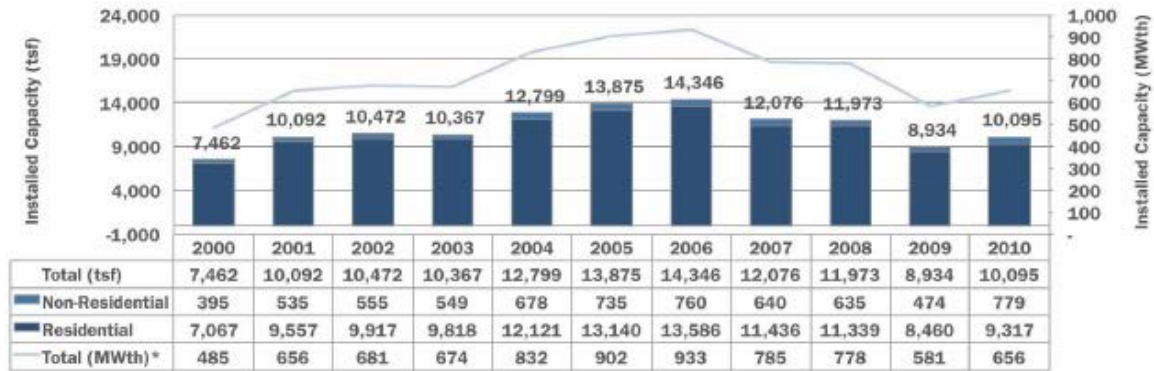

Figure C–4. Annual installed capacity by market segment, 2000–2010. (SEIA, used by permission)

Appendix D. Material Specifications for a Polymer Solar Water Heating System

Based on an indirect SWH system containing pressurized propylene glycol.
Solar collector: 75 ft²; HX: 3000 W (37.5 ft²); Storage tank: 80 gal (27.5 ft³)

	Average Operating Temp.	Maximum Operating Temp.	Maximum Operating Pressure MPa (psi)	Tensile Strength MPa (psi)	Material Compatibility	Material Creep (%/year)	Permeability @ 60°C (cc-mm/m ² -atm-day)	Ultraviolet Degradation (%/year)	Component Lifetime (years)	Target Material Cost
Solar Collector									25*	\$10.76/m ² (\$1/ft ²)
Absorber 7 m ² (75 ft ²)	60°C	140°C	0.4 MPa (60 psi)		Glycol, distilled water	<0.5%/yr	<10,000	0.3%/yr in absorptance		
Glazing 7 m ² (75 ft ²)	40°C	90°C				<0.5%/yr		0.3%/yr in transmittance		
Enclosure	40°C	90°C				<0.5%/yr				
HX									15	\$10.76/m ² (\$1/ft ²)
Solar-side	60°C	120°C	0.4 MPa (60 psi)	>10 MPa @ 82°C	Glycol, distilled water	<0.1%/yr		N/A		
Water-side	60°C	90°C	1.1 MPa @ 82°C	>14 MPa @ 82°C	Chlorinated water	<0.1%/yr		N/A		
Storage									15	\$19.38/m ² (\$1.80/ft ²)
Tank 302.8 liters (80 gallons)	60°C	85°C	1.1 MPa @ 82°C		Chlorinated water	<0.25%/yr	<50,000	N/A		
Fittings	60°C	85°C	1.1 MPa @ 82°C		Chlorinated water	<0.05%/yr	<10,000	N/A		
Balance of System									15	\$100 (FOB)
Pump	60°C	60°C	(60 psi)		Glycol, water		<10,000	N/A		
Piping 30.5m (100 ft)	60°C	140°C	1.1 MPa @ 82°C	>14 MPa @ 82°C	Glycol, distilled water		<10,000	N/A		
Valves	60°C	60°C	(60 psi)		Glycol, water		<10,000	N/A		
Control	25°C	40°C						N/A		

* Collector lifetime may be reduced with lower cost materials

Appendix E. Price Fluctuations for Commodities

(U.S. Bureau of Labor Statistics 2011)



Figure E-1. Copper ores producer price index—commodities, 1994–2011



Figure E-2. Aluminum mill shapes producer price index—commodities, 1994–2011

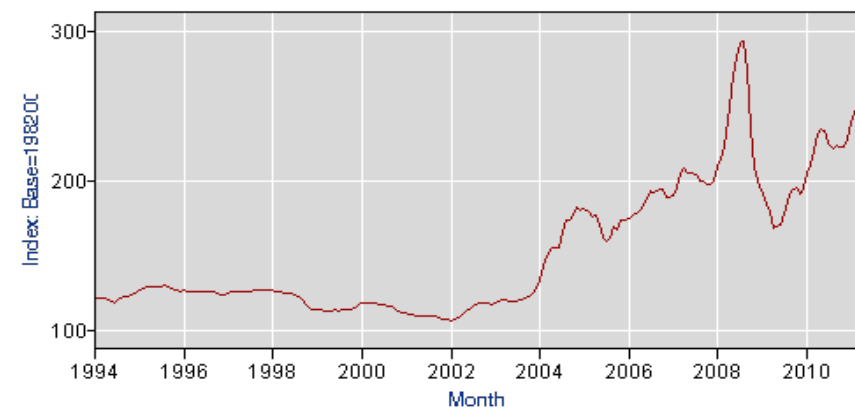

Figure E-3. Iron and steel producer price index—commodities, 1994–2011

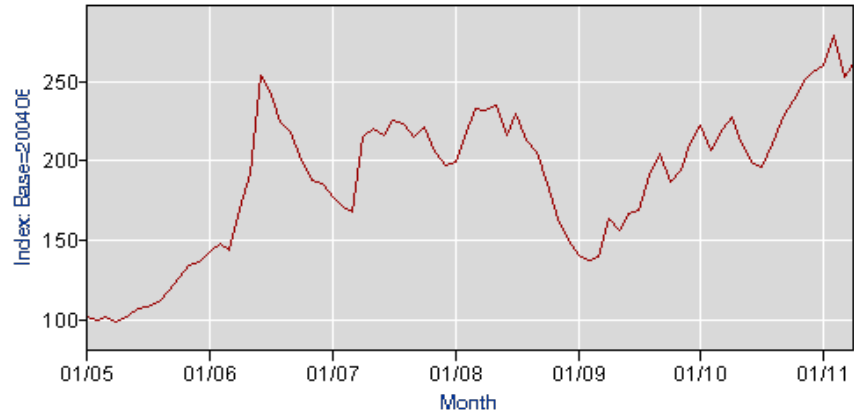

Figure E-4. Copper and copper-based alloy pipe and tube producer price index—commodities, 2005–2011

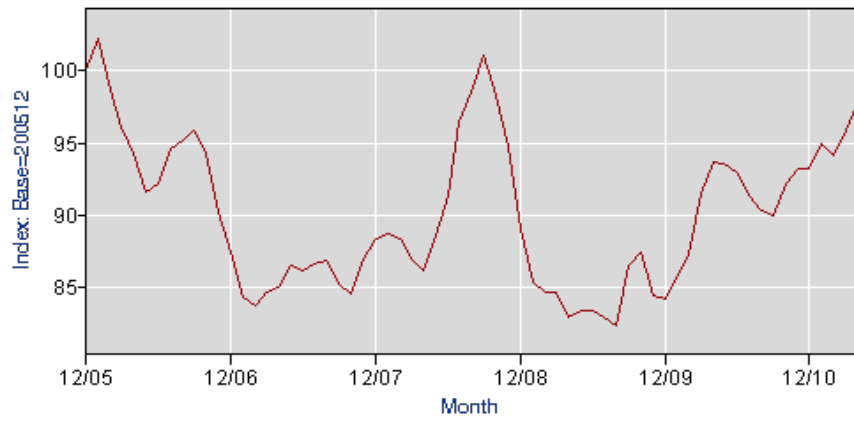

Figure E-5. Plastic pipe producer price index—commodities, 2005–2011